



STARTUP NY CAMPUS PLAN FOR DESIGNATION OF TAX-FREE AREA(S)

Campus Name: **Hudson Valley Community College**
Campus Contact 1 Name: **Roger Ramsammy, PhD**
Campus Contact 1 Title: **President**
Campus Contact 1 E-mail: r.ramsammy@hvcc.edu
Campus Contact 1 Phone: **(518) 629-4530**
Campus Contact 2 Name: **Penny Hill**
Campus Contact 2 Title: **Dean, Economic Development and Workforce Initiatives**
Campus Contact 2 E-mail: p.hill@hvcc.edu
Campus Contact 2 Phone: **(518) 629-7294**

THE TAX-FREE AREA PLAN SHALL BE DEVELOPED BY THE CAMPUS TEAM AND PROVIDE THE FOLLOWING REQUIRED INFORMATION:

- 1) Specification or identification of space or land proposed for designation as a Tax-Free Area identifying the following:
 - i. Provide the name and address of the SUNY, CUNY or community college seeking approval as a Sponsor, the address of the space or land proposed for designation as a Tax-Free Area, and a written description of the physical characteristics of the area for designation.

Name: <i>Hudson Valley Community College (HVCC)</i>
Campus Addresses: <i>80 Vandenberg Avenue Troy, New York 12180 (primary), Capital District Educational Opportunity Center (EOC) 431 River Street, Troy, NY 12180 (secondary) and HVCC TEC-SMART extension campus 345 Hermes Road Malta, NY 12020 (secondary) See map below.</i>

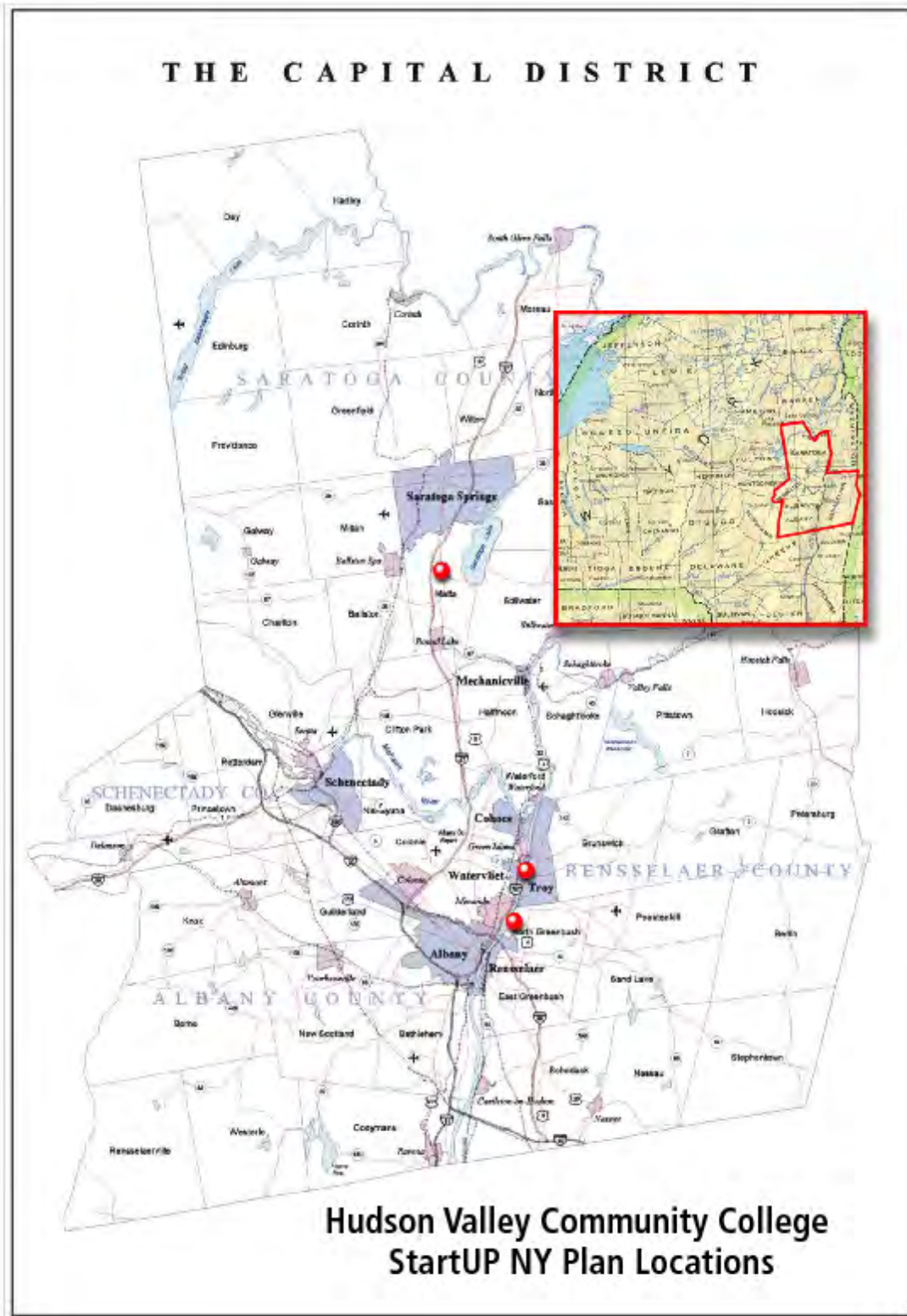

Address(es) of Proposed Tax-Free Area(s) :

OFF CAMPUS properties designated for Tax-Free Areas at this time will be in three general locations.

A. Sixteen properties containing VACANT spaces close to the HVCC EOC Downtown Troy address of 431 River Street Troy, 12180, the heart of an urban center with strong ties to industrial history. This area is experiencing high demand for space. The buildings are located at:

- 195 Cohoes Avenue, Green Island, NY 12183
- 75 102nd Street, Troy, NY 12180
- 32 Third Street, Troy, NY 12180
- 500 Federal Street, Troy, NY 12180
- 5 Third Street, Troy, NY 12180
- 2 Third Street, Troy, NY 12180
- 291 River Street, Troy, NY 12180
- 35 Fourth Street, Troy, NY 12180
- 274 2nd Street, Troy, NY 12180
- 275 Fourth Street, Troy, NY 12180
- 225 River Street, Troy, NY 12180
- 251 River Street, Troy, NY 12180
- 255 River Street, Troy, NY 12180
- 403 Fulton Street, Troy, NY 12180
- 5 First Street, Troy, NY 12180
- 2247 13th Street, Troy, NY 12180

B. One Property near the College's Main Campus at 80 Vandenburg Avenue, Troy, NY 12180

- 22 Hamilton Way, Castleton-on-Hudson, NY 12033

C. One Property near the College's Extension Campus on 345 Hermes Road, Malta NY 12020

- 107Hermes Road, Malta, NY 12020

Three ON- CAMPUS VACANT properties will now be included in the HVCC StartUP NY plan by virtue of affiliation agreements with the Rensselaer County IDA (RCIDA) and the Schodack Wildcat Foundation.

- 19 Third Street, Troy, NY 12180
- 5 East Industrial Parkway, Troy, NY 12180
- 1477 South Schodack Road, Castleton, NY 12033

Description of Physical Characteristics of Proposed Tax-Free Area(s):

- 195 Cohoes Avenue in Green Island is a privately held property across the river from the downtown Troy hub. It is expanding with new construction attached to an existing building. This location is located in an Industrial park setting 1.5 miles from the Downtown Troy Campus and HVCC seeks ESD waivers for Start-UP NY designation with 28,800 square feet of new manufacturing space. (SU-315-2-B-T2195-000-U)
- The property at 75 102nd Street in Troy is an existing underutilized building with suites that will be designated as Tax-Free Area of 18,036 square feet. These vacant

spaces include open suites and some larger floor space designated for manufacturing, office and light industrial purposes. The privately held building is located 1.4 miles from the downtown HVCC Troy campus. HVCC seeks ESD waivers for Start-UP NY designation. (SU-315-2-B-T2079-000-A)

- *The Quackenbush Building located at 32 Third Street has been newly renovated and will offer multiple vacant spaces and suites on floor one through four comprising 13,737 square feet of off-campus space for Tax-Free Area designation. Within these spaces, the Center of Gravity will offer a variety of shared business services including access to equipment for design, prototyping, and manufacturing, and shared access to professional expertise. Using the Quackenbush space for this purpose leverages CFA funds that are being used for the renovation. There is a possible StartUP NY software company looking at that space. (SU-315-2-B-T2032-001,2,3,4-A).*
- *Property located prominently at 500 Federal Street is a newer vacant office space on the second and fourth floors with 7,406 square feet recently renovated in downtown district good for computer software, mixed use office space. (SU-315-2-B-T2500-004-A and SU-315-2-B-T2500-002-A)*
- *Two floors, second and third floors consisting of 11,811 combined square feet in the building known as the Market Block Building located at the corner of 5 Third Street have recently been renovated and is now vacant. The space is ideal for IT/software design operations. One of the current growing StartUP NY software development companies are hoping to move into the vacant recently renovated space (SU-315-2-B-T2005-002-A and SU-315-2-B-T2005-003-A).*
- *A recently renovated 19th century historic building in the heart of the downtown at 2 Third Street, the Frear building has a total of 8,230 vacant square feet on the second and third floors suitable for mixed office, computer companies and newly formed businesses. A recently formed potential StartUP NY Software company is seeking to locate in this new space. (SU-315-2-B-T2002-002-A and SU-315-2-B-T2002-003-A)*
- *Another historic renovation on 291 River Street, Troy has 1,435 square feet of Tax-Free area or the entire vacant second floor for office and or IT/computer operations. (SU-315-2-B-T2291-002-A)*
- *Property located at 35 Fourth Street known as the Uncle Sam Transit Center has 3,500 square feet of vacant space suitable for mixed office and distribution center use on the first floor. (SU-315-2-B-T2035-001-A)*
- *Property on 274 Second Street in Troy has a new owner. The site is an older, two-floor industrial building being renovated and will now offer 13,558 square feet vacant space as Tax Free Area. This vacant space offers light manufacturing, office and warehouse space is 1.4 miles from the College downtown campus. HVCC seeks ESD waivers for Start-UP NY designation. (SU-315-2-B-T2274-001,2-A)*

- *Also, part of the urban revitalization effort in downtown Troy is located at 275 Fourth Street in Troy. Once a bar, this trendy vacant space of 990 square feet on the ground floor is perfect for a small computer company or offices for a StartUP NY partner. (SU-315-2-B-T2275-001-A)*
- *A newly renovated property known as the Sentinel Building located at 225 River Street, Troy will offer 2,600 square feet of vacant second and third floors of space for office, computer operations and other mixed uses. This property offers amazing views of the Hudson River. (SU-315-2-B-T2225-002,3-A)*
- *Another historic renovation on 251 River Street, Troy is known as the Burdett Building. It will offer 4,924 square feet of Tax-Free area or the entire vacant fifth floor for office and or IT/computer operations. (SU-315-2-B-T2251-005-A)*
- *Adding to the downtown Troy cluster of historic renovated spaces will be the McCarthy Building at 255 River Street. The beautiful vacant first floor, mezzanine and second floor will offer a total of 10,888 square feet for office and or computer operations. This for mixed-use Tax-free area. (SU-315-2-B-T2255-001,2-A)*
- *Two floors of a visible, corner building in the heart of the downtown economic cluster of Troy comprises 6,115 square feet located at 403 Fulton Street. This newly renovated vacant space has lots of natural light and would be suitable for computer software companies and offices. (SU-315-2-B-T2403-002,3-A)*
- *Four floors of an iconic 19th Century Troy building offers 11,547 square feet of vacant space. Known as the Rice building, this space dates from the prosperous Victorian era, the building at 5 First Street has suites and open space on four floors suitable for computer software design companies, offices or light assembly. (SU-315-2-B-T2005R-001,2,3,4-A)*
- *Located at 2247 13th Street is a new space of 5,544 square feet that once was classrooms in St. Paul's School. The Center for Purposeful Creation takes up the first and second floors of this vacant building, these suites are perfect for entrepreneurial work spaces, creative design or software development. (SU-315-2-B-T22238-001,2-A)*
- *A building located at 22 Hamilton Way Castleton-on Hudson 12033 located near the Main Campus in North Greenbush is being renovated for exclusive use by a StartUP NY company. This in a former printing shop that has been vacant for several years. 7,400 square feet of primarily administrative office space is located within in a much larger industrial manufacturing space. The brick structure is excellent as mixed-use with industrial/manufacturing space and office administration space. HVCC seeks a distance waiver from ESD for Start-UP NY designation for this vacant property. (SU-315-1-B-T1022-000-U)*
- *Two story suite in a newer mixed-use office building located at 107 Hermes Road, Malta 12020 is situated in a technology park next door to HVCC Extension Campus*

and in close proximity to an international Semiconductor Manufacturing Fab. This vacant space is ideal for a relocating or growing technology company and contains a total of 31,304 square feet. (SU-315-2-B-M0107-001-A, SU-315-2-B-M0107-002-A)

- *Recently renovated vacant space of 7,057 square feet on the second floor of a historical Masonic Hall is located at 19 Third Street Troy NY 12020. It is available in its entirety or divided into smaller suites. The space is centrally located in a software and gaming hub for budding computer programming companies or general office use. One current StartUP NY partner is considering expanding into this space. (SU-315-1-B-T2019-002-A)*
- *Vacant land comprising a total of 11.25 acres is located at 5 East Industrial Parkway in Troy will be a Tax-Free Area. The property is divided into two plots, is zoned industrial and ready for manufacturing or warehousing operations to build and develop. It will be considered ON-CAMPUS space through an Affiliation Agreement with the Rensselaer County IDA. (SU-315-1-L-T2005-00A,B-A).*
- *Vacant basement space of 6,500 square feet located in the Schodack Middle School at 1477 South Schodack Road will be available as tax-free space for small startup companies to locate. This property is also considered ON-CAMPUS space because of an Affiliation Agreement between the College and the Schodack Wildcat Foundation, a non-profit established by Schodack School District. (SU-315-1-B-T11477-000-A).*

- i. Complete the Excel spreadsheet template provided with this document, noting the instructions on page 2. Include the official SUNY Physical Space Inventory (PSI) building number and a clear description of the spaces in the building or floor (when the entire floor is under consideration), or floor/wing (with outer rooms defining the space specifically listed). Include only properties sought to be designated now and exclude potential sites that may be considered in the future (see 2a below). Attach the completed spreadsheet to this plan.
- ii. Provide also a representation of each proposed site drawn in AutoCAD on a scaled campus map with boundaries drawn clearly. Two versions should be created; one including an imbedded layer from Google Earth or other aerial photograph of the property. The second version should exclude the photographic imagery. Each parcel under consideration must have a unique alpha numeric identifier, clearly labeled on each plan which ties to identifiers in the Excel spreadsheet. If digital files containing Polygon shapefile that delineates area for designation are available, provide these as well. Attach these materials to this plan.
- iii. Provide a campus map with each proposed building shaded. Label each building with the official building number as listed in the SUNY Physical Space Inventory (PSI) along with the building name. For each building shaded and labeled, include floor plans of all areas under consideration with the specific spaces clearly shaded and labeled with official PSI room numbers. If digital files containing Point shapefiles that provide locations of area for designation are available, provide these as well. Attach these materials to this plan.

- 2) The total square footage of the space and/or acreage of land proposed for designation as a Tax-Free Area is:

The total number of OFF-CAMPUS square feet designated at this time is 187,825 square feet in sixteen properties.
The total number of ON-CAMPUS square feet designated at this time is 13,557 square feet and 11.25 acres.
TOTAL COMBINED OFF-CAMPUS and ON-CAMPUS space designated is: 201,382 square feet and 11.25 acres

- 2a) *If applicable:* You may include here a description of any potential space or acreage of land that you may seek to designate as a Tax-Free Areas under the START-UP NY Program in the future. This may include campus property that may become vacant, or other properties in your community that are not currently part of your campus but may be desirable for a company partner and with which you may consider an affiliation if an appropriate partner is identified. Do not include these properties in the Excel spreadsheet.

Space on all the Hudson Valley Community College campuses is very limited and most office and existing classroom space has been specifically earmarked for educational purposes. Open land around the campus is constrained by development. OFF-CAMPUS available square feet designated for the StartUP NY program is approaching the maximum capacity of the 200,000 square feet. Future amendments will probably remove and re-allocate space that have filled with non-StartUP NY companies and businesses. Some limited space and acreage can be found within a mile of each of all three HVCC sites for future designation as Tax-Free Areas and StartUP NY business development as business partners are identified :

- *The Troy campus is located on 80 Vandenburg Avenue in Troy. In proximity to this space are mixed use and suburban spaces, industrial parks and limited vacant land. These spaces are likely candidates for future Tax-Free designations.*
- *The HVCC Malta extension campus is located 25 miles north of Troy at 345 Hermes Road in Saratoga County in the towns of Malta and Stillwater. TEC-SMART, the Training and Education Center for Semiconductor Manufacturing and Alternative and Renewable Technologies is located at the Saratoga Technology and Energy Park® (STEP®) owned and operated by New York State Energy Research and Development Authority (NYSERDA). The location is next to the Luther Forest Technology Campus, a 1,350-acre campus designed for nanotechnology manufacturing and research and development which houses semiconductor manufacturer GLOBALFOUNDRIES. Both STEP and Luther Forest parks have space and/or buildings which may be open for development ideal for alternative energy, high tech and manufacturing businesses.*
- *Additional potential Tax-Free area sites exist near the EOC campus at the Hedley Plaza in downtown Troy.*
- *Future potential of Tax-free area space designations will probably fall into developing more Affiliation Agreements with non-profit entities, including IDA's as ON-CAMPUS space where there is no limit to the mile-radius or 200,000 square foot limit of space.*

- 2b) *If applicable:* The total square footage of the space or acreage of land that you may propose to designate as a Tax-Free Area as identified in 2a, if known.

- *Undetermined*

- 3) Provide a description of the type of business or businesses that may locate in the area identified in #1.

The types of businesses that the College is most interested in pursuing include new and expanding biolife sciences and biotech businesses, nanotechnology, semiconductor development, chemical manufacturing and most advanced manufacturing companies. Businesses related to technology development for clean energy production such as existing and emerging fields of solar, wind, geothermal, battery, fuel-cell, biomass and others will be considered for sponsorship. Businesses engaged in energy generation or distribution will not be considered (program regulations §220.6 (b)(1)(xiii). Additionally, HVCC would consider businesses relating to computer science and information systems, web development, health information, management information and other computing businesses.

HVCC will consider start-ups and existing business that will partner with College's new Entrepreneurship A.A.S. degree, which directs students through the start-up pathway, will be deemed relevant if the start-up is in direct alignment with or indirectly lends support to any of the types of business mentioned above. Businesses that list these categories as their primary business and are noted by the Capital Region's regional economic development council as important to the development of the region would be targets for the College's sites. HVCC will NOT consider including any of the businesses prohibited by the StartUP NY regulations

- 4) Provide a description of the campus academic mission, and explain how the businesses identified in #3 will align or further the academic mission of the university or college.

Hudson Valley Community College's vision is to "Deliver what the future demands". The College positions itself to meet the demands of a rapidly transforming world. In delivering a dynamic learning environment, the college prepares those it serves to meet the obligations inherent in being productive and responsible citizens and stewards of a global community. The mission of the College is "to provide dynamic, student-centered, comprehensive, and accessible educational opportunities that address the diverse needs of the community." Both vision and mission serve to frame the strategic directions the college plans to take to enable it to best serve the needs and concerns of its students, faculty, and staff, as well as those of the Capital Region, the State of New York, and the country as a whole. Types of businesses that the college is interested in designating appropriate for consideration are those which reinforce and support college programs and have a linkage to the College's broad vision and mission.

Businesses selected for sponsorship will align with the mission of the college in knowledge creation, knowledge diffusion, and formation of values. These businesses must demonstrate the potential to enhance the college's ability to offer a comprehensive education (both technical and traditional) and offer benefits in the following ways:

- Act as a recruiting tool and improve enrollment in specific areas of specialization of the colleges 85+ degree and certificate programs including alternative energy, IT and computer science, advanced manufacturing, semiconductor manufacturing, business education, entrepreneurship, biotechnology and other emerging technologies *(Table 1 listing specific NYSED Curriculum Codes where alignment occurs below)*
- Guide intellectual growth and innovation by providing leadership and participation in college advisory and campus committees*

- Incorporate real-world process and skill requirements into college program curricula by assisting with course review and development*
- Provide internship and training opportunities for hands-on vocational training and learning experiences for students that includes student access to resources and actual equipment*
- Provide actual business learning opportunities with links to entrepreneurship and business classes*
- Provide direct job opportunities for campus graduates*

TABLE 1 Alignment *HVCC Program Title	Award Type	NYSED Curriculum Codes
Alternative energy (Clean Energy Management)	AAS	37789
IT and computer science degrees	AS, CERT	30084,30398
IT and computer science degrees	AAS	28664,28665,28666
IT and Computer science degrees	AAS	28668,00946
Digital marketing	AAS	36881
Advanced manufacturing technology	AOS	00970,24453
Semiconductor manufacturing technology	AAS	29247
Business Administration	AS	77162
Business Administration	AAS	00926,19460,00931
Entrepreneurship	AAS, CERT	35638,36269
Biotechnology	AS, CERT	24991,32366
Other emerging technologies (mechatronics)	AAS	36959

- 5) Provide a description of how participation by these types of businesses in the START-UP NY Program will generate positive community and economic benefits, including but not limited to:
- Increased employment opportunities;
 - Increased opportunities for internships, vocational training and experiential learning for undergraduate and graduate study;
 - Diversification of the local economy;
 - Environmental sustainability;
 - Increased entrepreneurship opportunities;
 - Positive, non-competitive and/or synergistic links to existing businesses;
 - Effect on the local economy; and
 - Opportunities as a magnet for economic and social growth.

Businesses seeking to partner with HVCC and occupy space around the campus in the StartUP NY program will need to demonstrate how they will generate positive community and economic benefits. Hudson Valley Community College will consider a variety of criteria to establish that a business will bring about those benefits. One criteria used for existing businesses in establishing how they will generate community benefits will be based on a statement of previously demonstrated commitment to the community where the business operated in. New and emerging businesses will need to identify the importance of community involvement in their mission statement and business plan and explain in their business application how they will provide a positive impact on the surrounding community. Types of benefits HVCC will be looking for include encouraging volunteerism within the community from hosting a blood drives to sponsoring a little league.

Guiding criteria determining economic benefits of the business applicant will include the following:

- *Increasing employment opportunities within the community at large and for graduates of HVCC's programs;*
- *Providing opportunities for internships, vocational training and experiential learning for undergraduate and graduate study;*
- *Creating positive linkages to existing business; especially small scale, existing local vendors and distributors.*

These criteria will boost local economy and create regional economic development and can be measured. HVCC will initially seek definition of these criteria from each businesses pursuing StartUP NY sponsorship on their business application. The businesses' progress towards the criteria will be evaluated and measured periodically by the college in the annual review process.

- 6.) Provide a description of the process the Sponsor (campus) will follow to select participating businesses. The description should identify the membership of any group or committee that may make recommendations, the final decision-maker, and the criteria that will be used to make decisions. This group or committee must include representation from faculty governance.

The criteria may include some or all of the following:

A. Academic and Research Alignment

1. Is the business in an industry aligned with current and/or developing University research, scholarly, and creative activity?
2. Does the business provide experiential learning and workforce opportunities (e.g., internships, fellowships, full-time jobs) for students and graduates?
3. Does the business provide areas for partnership and advancement for faculty and students?
4. Will the business provide access to research instrumentation, tools, and/or equipment necessary to advance the academic and research mission?
5. Will the business fund scholarships, campus facilities or other academic services or amenities?
6. Will the business and/or its employees contribute to instruction or provide student mentoring?
7. Does the business offer the use of company resources, intellectual property or expertise to support the academic mission?

B. Economic Benefit

1. How many net new jobs will be created?
2. Is the business viable in both the short- and long-term?
3. Will the business attract private financial investment?
4. Does the business plan to make capital investments (e.g., renovation, new construction)?
5. Are the new jobs in critical areas of the economy?
6. How will the University financially benefit from the terms of the lease?

C. Community Benefits

1. Does the business have the support of one or more municipal or community entities?
2. Is the business recruiting employees from the local workforce?
3. Does the business invest in underserved, economically distressed regions?
4. Will the business rely on suppliers within the local and regional economy?

HVCC will use the following internal selection process to determine appropriateness and sponsorship of an interested business for participation in the StartUp NY program :

Step 1: The President of Hudson Valley Community College will designate a StartUp NY Committee made up of appropriate representation from various departments including: Business Operations and Finance, Academic Vice President, Chief Development Officer, and the Vice President for Enrollment Management and Student Development, the Dean for Economic Development and Workforce Initiatives, the Director for Center for Careers and Transfers, a selected faculty member whose department would benefit from the business partnership, a student designee from the Student Senate, and business members of the community will be invited.

Step 2: Interested businesses will submit a completed business application to the College President. Within this document the business will detail how their company will benefit the college and the local community. Information included in this document will detail the number of positions expected in the first and subsequent years, how internship opportunities for students will be structured, and what benefits they will bring to the community.

Step 3: The business application and prospectus will be reviewed by the StartUp NY Committee.

1. *The Committee will first determine if the type of business applicant is eligible for sponsorship.*
2. *Second, the committee will consider if the business applicant will align or further the academic mission of the university or college and be a good fit for existing college degree programs. The Committee will determine which program department chairs would most likely be aligned with the business and invite them to comment. To accomplish this, the Committee will look at whether or not the business will offer:*
 - *Experiential learning, internships, and career opportunities for students.*
 - *Scholarships or equipment donations to the college.*
 - *Senior staff from the company is willing to serve on the appropriate department's Advisement Board.*
3. *Finally, the Committee will review the business application for overall economic benefits and value to the community. Upon positive answers to the evaluation stage gates, the committee will respond accordingly to recommend the business for sponsorship.*

Step 4: A StartUp NY Committee designee will assure there are no known direct competitors to the business in the region. The steps to assure no competition include: search the NAICS Code indicated on the application for matching existing businesses an existing local business, contact regional economic development entities and Chambers of Commerce seeking their input, place an advertisement in local newspapers for any potential competition to the interested company.

-If the business is deemed NOT eligible, by virtue of having a direct competitor, or for any other reason the Committee/designee will notify the business in a timely manner that

the college does not intend to sponsor them for the StartUp NY program. The College President will make the final determination if the business is deemed appropriate.

1.) DEPARTMENT OF ECONOMIC DEVELOPMENT EXCEL SPREADSHEET
TEMPLATE LISTING ALL DESIGNATED PROPERTIES

SEE ATTACHEMENT

2.) COPY OF ANY OTHER APPLICABLE CONFLICT OF INTEREST
POLICIES OR GUIDELINES

3.) EVIDENCE OF SUBMISSION OF TAX-FREE AREA PLAN TO
INTERESTED PARTIES, I.E., COPIES OF CORRESPONDENCE SENT AND
RECEIVED

Space Inventory
Hudson Valley Community College

Off-Campus Location within a mile of:	UniqueID	Owner	Property Type	Street Address	City	Zip Code	Parcel ID	Building	Space Type	SqFt	Acres	Description	ON Campus	Within 1 mile of Campus	Latitude	Longitude	Notes
HVCC Troy - Downtown	SU-315-2-B-T2195-000-U	Case	2	195 Cohoes Avenue	Green Island	12183	20.12-5-1.11	Case	G	28,800		28,800 sq. ft. of newly built manufacturing space in an industrial park	NO	NO*	42.45°25.73"N	73.41°31.91"W	1.37 miles seeks waiver
	SU-315-2-B-T2075-000-A	Ross	2	75 102 nd Street	Troy	12180	90.47-3-2	Ross	G	18,036		18,036 sq. ft. of vacant space in multiple open suites and some larger floor space designated for manufacturing in tech park	NO	NO*	42.45°20.04"N	73.40°40.59"W	1.42 miles seeks waiver
	SU-315-2-B-T2032-001-A	David Bryce jr.	2	32 Third Street	Troy	12180	101.53-9-1	Quackenbush	G	2,165		2,165 square feet on the 1st floor of 32 Third street refurbished for general office, light industrial	NO	YES	42.45°51.63"N	73.41°24.17"W	
	SU-315-2-B-T2032-002-A	David Bryce jr.	2	32 Third Street	Troy	12180	101.53-9-1	Quackenbush	G	6,278		6,278 square feet on the 2nd floor of 32 Third street refurbished for general office, light industrial, manufacturing	NO	YES	42.45°51.63"N	73.41°24.17"W	1,394 additional space on second floor
	SU-315-2-B-T2032-003-A	David Bryce jr.	2	32 Third Street	Troy	12180	101.53-9-1	Quackenbush	G	906		906 square feet on the 3rd floor of 32 Third Street, Suites 370, and 380 are refurbished for computer companies or general office	NO	YES	42.45°51.63"N	73.41°24.17"W	
	SU-315-2-B-T2032-004-A	David Bryce jr.	2	32 Third Street	Troy	12180	101.53-9-1	Quackenbush	G	4,388		A total of 4,388 sq. ft. of newly refurbished space on the fourth floor suitable for general office, computer and software company use in six suites: 410, 420, 430, 460, 470 and 467	NO	YES	42.45°51.63"N	73.41°24.17"W	
	SU-315-2-B-T2500-004-A	David Bryce jr.	2	500 Federal Street	Troy	12180	101.45-2.1.1	Federal	G	4,035		4,035 office space recently renovated space on Fourth Floor in downtown district good for computer software, mixed use office space	NO	YES	42.44°1.4"N	73.41°16.3"W	
	SU-315-2-B-T2500-002-A	David Bryce jr.	2	500 Federal Street	Troy	12180	101.45-2.1.1	Federal	G	3,371		3,371 office space recently renovated space on Second Floor in downtown district good for computer software, mixed use office space	NO	YES	42.44°1.4"N	73.41°16.3"W	
	SU-315-2-B-T2005M-002-A	David Bryce jr.	2	5 Third Street	Troy	12180	101.45-9-1	Market Block	G	6,168		Newly renovated office space on second floor of 6,168 square feet will make ideal space for computer/software companies in heart of downtown historic district	NO	YES	42.73°21.87"	73.69°2.86"	
	SU-315-2-B-T2005M-003-A	David Bryce jr.	2	5 Third Street	Troy	12180	101.45-9-1	Market Block	G	5,643		5,643 square feet on third floor of newly renovated office space ideal for computer/software companies in heart of downtown historic district	NO	YES	42.73°21.87"	73.69°2.86"	
	SU-315-2-B-T2002-002-A	David Bryce jr.	2	2 Third Street	Troy	12180	101.45-6-1	Frear Building	G	4,458		4,458 sq. ft. of space on second floor to create one large suite in an historic 19th century building in the heart of the downtown area are bright with natural light, walkable for computer companies, and newly formed businesses.	NO	YES	73.41°22.0"W	73.41°22.0"W	4,458 NEW SQ.FT 2nd FLOOR
	SU-315-2-B-T2002-003-A	David Bryce jr.	2	2 Third Street	Troy	12180	101.45-6-1	Frear Building	G	3,772		3,772 sq. ft. of space on third floor to create two suites on the third floor in an historic 19th century building in the heart of the downtown area are bright with natural light, walkable and available for computer companies, and newly formed businesses.	NO	YES	42.43°56.0"N	73.41°22.0"W	
	SU-315-2-B-T2291-002-A	David Bryce jr.	2	291 River Street	Troy	12180	101.45-9-1		G	1,435		1,435 square feet in a newly renovated historic building in a very desirable downtown space for computer or business offices	NO	YES	42.43°55.65"N	73.41°24.3"W	
	SU-315-2-B-T2035-001-A	David Bryce, jr.	2	35 Fourth Street	Troy	12180	101.45-3-2	Uncle Sam Transit Center	G	3,500		3,500 square feet of first floor space could be used as office/ distribution center near parking in prime downtown area	NO	YES	42.43°50.5"N	73.41°19.1"W	
	SU-315-2-B-T2274-001-A	Dylan Turek	2	274 2nd Street	Troy	12180	100.84-7-14		G	8,482		Urban revitalization of 8,482 square feet of vacant renovated space on first floor renovated for light manufacturing and office space	NO	NO*	42.43°15.14"N	73.41°37.04"W	1.4 miles seeks waiver space changes

Space Inventory
Hudson Valley Community College

Off-Campus Location within a mile of:	UniqueID	Owner	Property Type	Street Address	City	Zip Code	Parcel ID	Building	Space Type	SqFt	Acres	Description	ON Campus	Within 1 mile of Campus	Latitude	Longitude	Notes
	SU-315-2-B-T2274-002-A	Dylan Turek	2	274 2nd Street	Troy	12180	100.84-7-14		G	5,076		Urban revitalization of 5,076 square feet of vacant renovated space on second floor renovated for light manufacturing and office space	NO	NO*	42.43'15.14"N	73.41'37.04"W	1.4 miles seeks waiver space modifications
	SU-315-2-B-T2275-001-A	Dylan Turek	2	275 Fourth Street	Troy	12180	101.77-8-5		G	990		iconic vacant bar part of urban revitalization and renovation transformed 990 square feet for startup computer companies and offices	NO	NO*	42.43'21.68"N	73.41'28.46"W	
	SU-315-2-B-T2225-002-A	225 River Street, LLC	2	225 River Street Second Floor	Troy	12180	100.6-1-3	Sentinel Building	G	1,300		Second floor historic renovation in urban downtown consisting of 1,300 square feet for office, mixed use	NO	YES	42.43'53.26"N	73.41'35.33"W	
	SU-315-2-B-T2225-003-A	225 River Street, LLC	2	225 River Street Third Floor	Troy	12180	100.6-1-3	Sentinel Building	G	1,300		Third floor historic renovation in urban downtown consisting of 1,300 square feet for office, mixed use	NO	YES	42.43'53.26"N	73.41'35.33"W	
	SU-315-2-B-T2251-005-A	Judge Development Corp.	2	251 River Street Fifth Floor	Troy	12180	101.45-5-4.2	Burdett	G	4,924		Entire 5th floor 4,924 sq. ft. renovated historic space in downtown urban area for office, computer company use	NO	YES	42.43'54.40"N	73.41'31.03"W	

Space Inventory
Hudson Valley Community College

Off-Campus Location within a mile of:	UniqueID	Owner	Property Type	Street Address	City	Zip Code	Parcel ID	Building	Space Type	SqFt	Acres	Description	ON Campus	Within 1 mile of Campus	Latitude	Longitude	Notes
	SU-315-2-B-T2255-001-A	Judge Development Corp.	2	255 River Street First Floor	Troy	12180	101.45-5-6	McCarthy	G	5987		First floor and mezzanine of historic renovation in urban downtown consisting of 5,987 square feet for office, mixed use	NO	YES	42.43'54.53"N	73.41'28.88"W	
	SU-315-2-B-T2255-002-A	Judge Development Corp.	2	255 River Street Second Floor	Troy	12180	101.45-5-6	McCarthy	G	4,901		Second floor historic renovation in urban downtown consisting of 4,901 square feet for office, mixed use	NO	YES	42.43'54.53"N	73.41'28.88"W	
	SU-315-2-B-T2403-002-A	Kyle Engstrom	2	403 Fulton Street	Troy	12180	101.45-7-1		G	3,065		Renovated second floor office in the heart of historical downtown district with multiple suites for computer/software companies. 3,065 sq.ft. trendy space with natural light	NO	YES	42.43'56.7"N	73.41'19"W	
	SU-315-2-B-T2403-003-A	Kyle Engstrom	2	403 Fulton Street	Troy	12180	101.45-7-1		G	3,050		Renovated third floor office in the heart of historical downtown district with multiple suites for computer/software companies. 3,050 sq.ft. trendy space with natural light	NO	YES	42.43'56.7"N	73.41'19"W	
	SU-315-2-B-T2005-001-A	Berkshire Hathaway	2	5 First Street	Troy	12180	100.60-2-1	Rice	G	970		970 square feet of newly renovated space in and iconic 19th Century architectural building in urban center. Several office configurations good for computer or software companies.	NO	YES	42.73'9.08"N	73.69'35.63"W	
	SU-315-2-B-T2005-002-A	Berkshire Hathaway	2	5 First Street	Troy	12180	100.60-2-1	Rice	G	2,647		2,647 sq. ft. of newly renovated space in an iconic 19th Century architectural building in urban center. Several office configurations good for computer or software companies.	NO	YES	42.73'9.08"N	73.69'35.63"W	
	SU-315-2-B-T2005-003-A	Berkshire Hathaway	2	5 First Street	Troy	12180	100.60-2-1	Rice	G	4,067		4,067 square feet of newly renovated iconic 19th Century architectural building in urban center. Several office configurations good for computer or software companies.	NO	YES	42.73'9.08"N	73.69'35.63"W	
	SU-315-2-B-T2005-004-A	Berkshire Hathaway	2	5 First Street	Troy	12180	100.60-2-1	Rice	G	3,863		3,863 square feet of newly renovated iconic 19th Century architectural building in urban center. Several office configurations good for computer or software companies.	NO	YES	42.73'9.08"N	73.69'35.63"W	
	SU-315-2-B-T2247-001-A	12th Street Ventures	2	2247 13th Street	Troy	12180	101.39-9-1	Center for Purposeful Creation Studios	G	2,772		2,772 square feet first floor renovated classroom space in vacant St. Paul's Church School converted to studio/office space for small start-up computer and artistic design companies	NO	YES	42.44'11.99"N	73.40'39.54W	
	SU-315-2-B-T2247-002-A	12th Street Ventures	2	2247 13th Street	Troy	12180	101.39-9-1	Center for Purposeful Creation Studios	G	2,772		2,772 square feet first floor renovated classroom space in vacant St. Paul's Church School converted to studio/office space for small start-up computer and artistic design companies	NO	YES	42.44'11.99"N	73.40'39.54W	
Troy-Main Campus	SU-315-2-B-T1022-000-U	Hamilton Industrial Corporation	2	22 Hamilton Way	Castleton-on-Hudson	12033	198-4-1.11	Hamilton Building	G	7,400		A total of 7,400 square feet in a vacant print shop is being converted to manufacturing space. Designating 3,400 sq. ft. of first floor offices and 4,000 sq. ft. second floor mezzanine office space for TFA.	NO	NO*	42.32'21.36"N	73.44'59.26"W	11.5 miles seeks waiver
Malta-Extension Campus TEC-SMART	SU-315-2-B-M107-001-A	United STEP I, LLC	2	107 Hermes Road	Malta	12020	230.-1.14.11-1		G	20,110		20,110 square feet in a series of suites on first floor, and one on the first and second floor of a newer mixed use building in technology park next door to HVCC Extension Campus and in close proximity to Semiconductor Fab. Ideal for relocating or growing technology company	NO	YES	42.96'84"N	73.76'95"	New space in immediate proximity to HVCC Extension Tech Campus
	SU-315-2-B-M107-002-A	United STEP I, LLC	2	107 Hermes Road	Malta	12020	230.-1.14.11-1		G	11,194		11,194 in a series of suites on second floor of a newer office space in technology park next door to HVCC Extension Campus and in close proximity to Semiconductor Fab. Ideal for relocating or growing technology company	NO	YES	42.96'84"N	73.76'95"	New space in immediate proximity to HVCC Extension Tech Campus
			OFF	CAMPUS					TOTAL	187,825							

Space Inventory
Hudson Valley Community College

Off-Campus Location within a mile of:	UniqueID	Owner	Property Type	Street Address	City	Zip Code	Parcel ID	Building	Space Type	SqFt	Acres	Description	ON Campus	Within 1 mile of Campus	Latitude	Longitude	Notes
HVCC Affiliation Agreements creating "On-Campus" space	SU-315-1-B-T2019-002-A	RCIDA	1	19 Third Street 2nd Floor	Troy	12180	101.53-9-1	Old Masonic Hall	B	7057		7,057 newly renovated space on the second floor of a historical masonic hall for division is available in its entirety or dividing into smaller suites. Space is centrally located in a software and gaming hub for budding computer programming companies or general office space	YES	n/a	42.43'54.22"	73.41'25.06"	NEW Space added to Affiliation Agreement RCIDA
	SU-315-1-L-T2005-00A-A	RCIDA	1	5 East Industrial Parkway	Troy	12180	111.44-1-1		D		4.3	PLOT A is 4.30 acres vacant land adjacent to the Hudson River available for development zoned industrial. Shovel-ready with access to electric, sewer and city water. FOR LEASE through MOA with IDA	YES	n/a	42.42'39.72"N	73.41'57.88"W	Affiliation Agreement RCIDA
	SU-315-1-L-T2005-00B-A	RCIDA	1	5 East Industrial Parkway	Troy	12180	111.44-1-1		D		6.95	PLOT B is 6.95 acres vacant land adjacent to the Hudson River available for development zoned industrial. Space can be subdivided into smaller plots, shovel-ready with access to electric, sewer and city water. FOR LEASE through MOA with IDA	YES	n/a	42.42'39.72"N	73.41'57.88"W	Affiliation Agreement RCIDA
	SU-315-1-B-T11477-000-A	SCHODACK SCHOOL DISTRICT through Schodack Wildcat Foundation, Inc.	1	1477 South Schodack Road Basement	Castleton	12033	209.-2-12	Maple Hill Middle School	C	6500		6,500 Vacant space within Maple Hill Middle School with concrete floor and walls partially below grade with two overhead garage doors. 10' ceilings, access to water, shared conference room and off street parking. Classrooms can be subdivided for incubator space for small start-up companies. For lease with Schodack Wildcat Foundation	YES	n/a	42.31'16.58"N	73.42'32.40"W	Affiliation Agreement with Schodack Wildcat Foundation - Schodack Middle School Basement
								ON-CAMPUS	Total	13557	11.25	TFA Designated ON CAMPUS space					
									A=entire building on campus								
									B=floor within building								
									C=Room within building								
									D=land on campus								
									E= land off campus								
									F=entire building off campus								
									G=partial building off campus								
									H=state asset								
Designated Land or Buildings Unique ID Standard																	
LL - ### - # - X - YYYYY - ZZZ - A																	
· LL - is SU for SUNY, CU for CUNY and PV for Privates																	
· ### is the State University Construction Fund's 3-digit code for the sponsoring campus. See the campus key on page 2.																	
· # - is a 1 for on campus and a 2 for off-campus																	
· X - is L, B or C for Land, Building or Combination																	
· YYYYY is the PSI building number or for land a campus assigned number																	
· ZZZ is an additional number, generally 000 but where there are several units within a single building each would get a unique identifier.																	
· A - Indicates A- if the property/space is currently available for a new business, U - is unavailable (for any reason other than 3), or I - is currently in use by a StartUp NY approved business																	
																	

3. *Procedures For Addressing The Conflict Of Interest* - an interested person may make a presentation at the Board or committee meeting, but after such presentation, he/she shall leave the meeting during the discussion of, and the vote on, the transaction or arrangement that results in the conflict of interest.
 - a. The chairperson of the Board or committee shall, if appropriate, appoint a disinterested person or committee to investigate alternatives to the proposed transaction or arrangement.
 - b. After exercising due diligence, the Board or committee shall determine whether the Foundation can obtain a more advantageous transaction or arrangement with reasonable efforts from a person or entity that would not give rise to a conflict of interest.
 - c. If a more advantageous transaction or arrangement is not reasonably attainable under circumstances that would not give rise to a conflict of interest, the Board or committee shall determine by a majority vote of the disinterested directors whether the transaction or arrangement is in the Foundation's best interest and for its own benefit and whether the transaction is fair and reasonable to the Foundation and shall make its decision as to whether to enter into the transaction or arrangement in conformity with such determination.
4. *Violations Of The Conflicts Of Interest Policy*
 - a. If the Board or committee has reasonable cause to believe that member has failed to disclose actual or possible conflicts of interest, it shall inform the member of the basis for such belief and afford the member an opportunity to explain the alleged failure to disclose.
 - b. If, after hearing the response of the member and making such further investigation as may be warranted in the circumstances, the board or committee determines that the member has in fact failed to disclose an actual or possible conflict of interest, it shall take appropriate disciplinary and corrective action.

ARTICLE IV - RECORDS OF PROCEEDINGS

The minutes of the Board and all committees with Board-delegated powers shall contain:

1. The names of the individuals who disclosed or otherwise were found to have a financial interest in connection with an actual or possible conflict of interest, the nature of the financial interest, any action taken to determine whether a conflict of interest was present, and the Board's or committee's decision as to whether a conflict of interest in fact existed.
2. The names of the individuals who were present for discussions and votes relating to the transaction or arrangement, the content of the discussion, including any alternatives to the proposed transaction or arrangement, and a record of any votes taken in connection therewith.

ARTICLE V- ANNUAL STATEMENTS

Each director, principal officer and member of a committee with Board-delegated powers shall annually sign a statement which affirms that such person:

1. has received a copy of the Conflict of Interest Policy,
2. has read and understands the policy,
3. has agreed to comply with the policy, and
4. understands that the Foundation is charitable organization and that in order to maintain its federal tax exemption it must engage primarily in activities which accomplish one or more of its tax-exempt purposes.

ARTICLE VI - PERIODIC REVIEWS

To ensure that the Corporation operates in a manner consistent with its charitable purposes and that it does not engage in activities that could jeopardize its status as an organization exempt from federal income tax, periodic reviews shall be conducted. The periodic reviews shall, at a minimum, include the following subjects:

1. Whether compensation arrangements and benefits are reasonable and are the result of arm's-length bargaining.
2. Whether partnership and joint venture arrangements and arrangements with management service organizations and physician hospital organizations conform to written policies, are properly recorded, reflect reasonable payments for goods and services, further the Corporation's charitable purposes and do not result in inurement or impermissible private benefit.
3. Whether agreements to provide health care and agreements with other health care providers, employees, and third party payors further the Corporation's charitable purposes and do not result in inurement or impermissible private benefit.

ARTICLE VIII - USE OF OUTSIDE EXPERTS

In conducting the periodic reviews provided for the Article VII, the Corporation may, but need not, use outside advisors. If outside experts are used their use shall not relieve the board of its responsibility for ensuring that periodic reviews are conducted.

**Annual Statement
of the Board of Directors of
The Foundation**

Each of the undersigned members of the Board of Directors of the Foundation states for himself or herself that he or she:

1. has received a copy of the conflicts of interest policy,
2. has read and understands the policy,
3. has agreed to comply with the policy, and
4. understands that The Foundation is a charitable organization and that in order to maintain its federal tax exemption it must engage primarily in activities which accomplish one or more of its tax-exempt purposes.

Name

Date

BYLAWS AND POLICY MANUAL
OF THE
HUDSON VALLEY COMMUNITY COLLEGE
BOARD OF TRUSTEES

APPENDIX A

HUDSON VALLEY COMMUNITY COLLEGE
BOARD OF TRUSTEES
Code of Ethics

Enacted by Resolution, October 25, 2011 and amended December 18, 2012

Article I: Purpose

The purpose of the Code of Ethics is (i) to protect the College's interest; (ii) to provide guidance to the Trustees and Officers of the Board exercising their fiduciary duties in the management of the College and its affairs, (iii) to provide a procedure for disclosure of potential conflicts of interest, and (iv) to establish standards of conduct. This policy is intended to supplement but not replace any applicable state laws governing conflicts of interest applicable to the Trustees of Community Colleges.

Article II: Definitions

"Acceptable Reasons" shall include only medical issues/illness, family emergencies, or other circumstances deemed extraordinary by the Board.

"Attend or Attendance" shall mean the presence throughout the meeting in person or by videoconferencing. While videoconferencing is an acceptable means of attendance, Board members are strongly encouraged to attend all meetings in person whenever possible.

"Conflict of Interest" shall mean that a Trustee or Officer of the Board has existing or potential financial or other interests which impair or might reasonably appear to impair such Trustee's or Officer's independent, unbiased judgment in the discharge of his or her responsibilities to the College, or such Trustee or Officer of the Board is aware that a member of his or her family, which for purposes of this Code of Ethics shall be a spouse, parents, siblings, children, and any other relative or person who resides in the same household as the Trustee or Officer of the Board, or any organization in which such Trustee or Officer of the Board (or member of his or her family) is an officer, director, employee, member, partner, trustee, or controlling stockholder, has such existing or potential financial or other interest. [HVCC Code of Ethics for Employees ("Employee Code") §6.291]

"Fiscal Year" shall mean each year commencing on September 1 and ending the following August 31.

"Prohibited Activity" shall mean and include:

1. No Trustee or Officer of the Board shall accept other employment which will impair his or her independence of judgment in the exercise of his or her official duties. [Public Officers Law ("POL")§74 3(a)]
2. No Trustee or Officer of the Board shall accept employment or engage in any business or professional activity which will require the Trustee or Officer of the Board to disclose confidential information which he or she has gained by reason of his official position or authority. [POL §74 3(b)] [Employee Code]
3. No Trustee or Officer of the Board shall disclose confidential information acquired by him or her in the course of official duties nor use such information to further his or her personal interests. [POL §74 3(c)] [GML §805-a (b)] [Employee Code]
4. No Trustee or Officer of the Board shall use or attempt to use his or her official position to secure unwarranted privileges or exemptions for himself or herself or others, including but not limited to, the misappropriation to himself, herself or to others of the property, services or other resources of the College for private business or other compensated nongovernmental purposes. [POL §74 3(d)] [Employee Code]
5. No Trustee or Officer of the Board shall engage in any transaction as representative or agent of the College with any business entity in which he or she has a direct or indirect financial interest that might reasonably tend to conflict with the proper discharge of official duties. [POL §73 3(e)] [Employee Code]
6. No Trustee or Officer of the Board shall by his or her conduct give reasonable basis for the impression that any person can improperly influence the Trustee or Officer of the Board or unduly enjoy his or her favor in the performance of official duties, or that he or she is affected by the kinship, rank, position or influence of any party or person. [POL §74 3(f)] [Employee Code]
7. A Trustee or Officer of the Board shall abstain from making personal investments in enterprises which he or she has reason to believe may be directly involved in decisions to be made by the Trustee or which will otherwise create substantial conflict between the Trustee's or Officer of the Board's duty in the public interest and his private interest. [POL §74 3(g)] [Employee Code]
8. A Trustee or Officer of the Board shall endeavor to pursue a course of conduct which will not raise suspicion among the public that he or she is likely to be engaged in acts that are in violation of trust. [POL §74 3(h)]
9. No Trustee or Officer of the Board shall directly or indirectly solicit any gift, or accept or receive any gift having a value of seventy-five dollars or more, whether in the form of money, service, loan travel, entertainment, hospitality, thing or promise, or in any other form, under circumstances in which it could reasonably be expected to influence him or her in the performance of official duties, or was intended as a reward for any official action on his or her part. [GML §805-a(1) (a)]

10. No Trustee or Officer of the Board shall receive or enter into any agreement, express or implied, for compensation for services to be rendered in relation to any matter before the Board of Trustees or the College. [GML §805-a(1) (c)]
11. No Trustee or Officer of the Board shall receive or enter into any agreement, express or implied, for compensation for services to be rendered in relation to any matter before the Board of Trustees or the College whereby the Trustee's or Officer of the Board's compensation is to be dependent or contingent upon any action with respect to such matter. [GML §805-a(1) (d)]
12. No Trustee or Officer of the Board shall allow his or her outside position or profession to influence or interfere with such officer's fiduciary obligations to the College.

Article III: Attendance

- A. A Trustee shall attend in person or by videoconferencing at least seventy-five percent (75%) of the regular and special meetings of the Board each fiscal year. If there are only eleven (11) regular meetings, each member shall attend at least 8. A member who intends to attend by videoconferencing shall notify the Assistant Secretary at least seven (7) days prior to the meeting to allow arrangements to be made to comply with Article 7 of the POL. The Assistant Secretary shall keep an annual attendance record for each Trustee. If a member will be unable to attend a meeting, he or she shall notify the Assistant Secretary that he or she will be unavailable and the reason for such unavailability as soon as possible. The Secretary shall note the reason for unavailability in the attendance record.
- B. The Chair of the Board of Trustees, Secretary or Assistant Secretary of the Board of Trustees shall notify the Appointing Authority in September of each year of the name of any Trustees who have not attended at least seventy-five percent (75%) of the regular and special meetings during the preceding Fiscal Year, and the reasons therefore if the Trustee provided Acceptable Reasons.

Article IV: Standard of Conduct and Procedures

- A. No Trustee or Officer of the Board shall engage in Prohibited Activity.
- B. Any Trustee or Officer of the Board who has, will have, or later acquires an interest in any actual or proposed contract with the College shall publicly disclose the nature and extent of such interest in writing to the Board of Trustees as soon as he or she has knowledge of such actual or prospective interest. Such written disclosure shall be made part of and be set forth in the official record of the proceedings of The Board of Trustees. Once a disclosure has been made with respect to an interest in a contract with a particular person, firm, corporation or association, no further disclosures need be made by such Trustee or Officer of the Board with respect to additional contracts with the same party during the remainder of the fiscal year. [GML §803(i)]
- C. After disclosure of a Conflict of Interest and all material facts, the Trustee or Officer of the Board shall leave the meeting and the Trustees shall determine by a vote of those present

whether a Conflict of Interest exists. If the Board of Trustees determines that a Conflict of Interest exists, it shall approve the transaction or arrangement if after any further investigation, it appears that the transaction or arrangement is in the best interests of the College. The interested Trustee or Officer of the Board shall not be present during the discussion nor participate in the vote.

D. Penalties

1. Any Trustee or Officer of the Board who willfully and knowingly violates the provisions of this Code of Ethics shall be subject to the penalties described in GML §805, where applicable.
2. The President shall notify the Chairman of the Board (or Vice Chair) if he or she believes that a Trustee or Officer of the Board has violated the provisions of this Code of Ethics. The Board of Trustees shall notify any Trustee or Officer of the Board it believes has violated the provisions of this Code of Ethics. The notification shall specify the section of the Code of Ethics alleged to have been violated and the facts and circumstances surrounding such allegations. The Trustee or Officer of the Board shall have an opportunity to present information, including documents and written and other oral statements to refute the allegations. The Trustees shall then determine by a majority vote whether the Board believes the violation occurred and may ask for the resignation of such Trustee or Officer of the Board, and such other relief as it may deem appropriate under the circumstances.



Category:
Academic Affairs
Community Colleges
Legal and Compliance
Research

Responsible Office:
[Academic Affairs](#)

Policy Title:
START-UP NY Program Participation Policy

Document Number:
6800

Effective Date:
February 10, 2014

This policy item applies to:
Community Colleges
State-Operated Campuses

Table of Contents

[Summary](#)

[Policy](#)

[Definitions](#)

[Other Related Information](#)

[Procedures](#)

[Forms](#)

[Authority](#)

[History](#)

[Appendices](#)

Summary

START-UP NY is a state economic development program that positions SUNY campuses as magnets for entrepreneurs and businesses from around the globe. START-UP NY aligns with SUNY's mission of teaching, research and public service; enabling engagement with industry, knowledge acceleration, translation of research into practical applications, and delivering the 21st century workforce businesses need to grow and thrive. START-UP NY will transform university communities to deliver unprecedented economic benefits to New York. To participate in the program, all campuses must comply with this policy and any applicable rules and regulations issued by the NYS Commissioner of Economic Development.

This policy governs the review process that all participating campuses must follow to secure SUNY's approval of the plans, applications, and other documents required by the NYS Commissioner of Economic Development to participate in the START-UP NY program. It also prescribes special requirements for the disclosure and management of actual or potential conflicts of interest in matters pertaining to the campus' START-UP NY program. Any conflict between this policy and any other applicable Conflict of Interest policy shall be resolved in favor of disclosure of any potential, actual, or perceived conflict of interest relating to the campus' START-UP NY program to the President or Chief Executive Officer of the sponsoring campus.

Policy

- A. **Campus Plans for Designation of Tax-Free Area(s):** Any campus intending to submit a Campus Plan for Designation of Tax-Free Area(s) ("Campus Plan") to the NYS Commissioner of Economic Development must first have it reviewed and approved by the Chancellor or designee. The Chancellor or designee shall approve or reject all Campus Plans within fifteen (15) business days of receipt. Any rejected Campus Plan shall be accompanied by an explanation of the basis for rejection. Once approved by the Chancellor or designee a campus may submit its Campus Plan to the NYS Commissioner of Economic Development in accordance with the Commissioner's rules and regulations. Any Campus Plan that is rejected can be resubmitted for Chancellor

or designee approval and will be reviewed in accordance with this policy and related procedures. Any amendments to approved Campus Plans must be submitted for Chancellor or designee approval and will be reviewed in accordance with this policy and related procedures.

- B. Sponsoring University or College Applications for Business Participation:** Any campus intending to submit a Sponsoring University or College Application for Business Participation ("Sponsor Application") to the NYS Commissioner of Economic Development must first have it reviewed and approved by the Chancellor or designee. The Chancellor or designee shall approve or reject all Sponsor Applications within thirty (30) business days of receipt. Any rejected Sponsor Application shall be accompanied by an explanation of the basis for rejection. Once approved the campus may submit the Sponsor Application to the NYS Commissioner of Economic Development in accordance with the Commissioner's rules and regulations. Any Sponsor Application that is rejected can be resubmitted for Chancellor or designee approval and will be reviewed in accordance with this policy and related procedures. Any amendments to approved Sponsor Applications must be submitted for Chancellor or designee approval and will be reviewed in accordance with this policy and related procedures.
- C. Delegations:** The Chancellor or designee may charge a group of individuals, collectively called the SUNY START-UP NY Proposal Review Team, to evaluate all submitted Campus Plans and Sponsor Applications prior to accepting or rejecting them.
- D. Conflicts of Interest:** Service as an Official shall not be used as a means for private benefit or inurement for any Official, a Relative thereof, or any entity in which the Official or Relative thereof has a Business Interest. A conflict of interest exists whenever an Official has a Business Interest or other interest or activity outside of the university that has the possibility, whether potential, actual, or perceived, of (a) compromising the Official's judgment, (b) influencing the Official's decision or behavior with respect to the START-UP NY Program, or (c) resulting in personal or a Relative's gain or advancement. Any Official who is an owner or employee of an entity that is the subject of any matter pertaining to the university's START-UP NY Program, or who has a Business Interest in any entity that is the subject of any matter pertaining to the university's START-UP NY Program, or whose Relative has such a Business Interest, shall not vote on or otherwise participate in the administration by the university of any START-UP NY matter involving such entity. Any Official or other campus representative who becomes aware of a potential, actual or apparent conflict of interest, either their own or that of another Official, related to a sponsoring university or college's START-UP NY program must disclose that interest to the President or Chief Executive Officer of the sponsoring college or university. Each such President or Chief Executive Officer shall maintain a written record of all disclosures of actual or potential conflicts of interest made pursuant to this policy, and shall report such disclosures on a calendar year basis, by January 31st of each year, to the University Auditor or to the Chancellor's designee, in which case the University Auditor shall be copied on the correspondence to such designee. SUNY shall then forward such reports to the Commissioner of Economic Development for the State of New York, who shall make public such reports.
- E. Exceptions:** There are no exceptions to this policy.

Definitions

Business Interest means that an individual (1) owns or controls 10% or more of the stock of an entity (or 1% in the case of an entity the stock of which is regularly traded on an established securities exchange); or (2) serves as an officer, director or partner of an entity.

Official means an employee at the level of dean and above as well as any other person with decision-making authority over a campus' START-UP NY Program, including any member of any panel or committee that recommends businesses for acceptance into the START-UP NY program.

Relative means any person living in the same household as another individual and any person who is a direct descendant of that individual's grandparents or the spouse of such descendant.

Sponsoring College or University means any entity defined or described in NYS Education Law Sec. 352 and Article 126.

START-UP NY Program means the SUNY Tax-free Areas to Revitalize and Transform Upstate New York Program established by Article 21 of the Economic Development Law.

Tax-Free NY Area means vacant land or space designated by the Commissioner of Economic Development Article

21 of the Economic Development Law that is eligible to receive benefits under the START-UP NY program.

Other Related Information

[Start-Up NY Regulations](#); available at the [Start-Up NY Website](#).

At least thirty days before submitting the Campus Plan to the Commissioner of Economic Development the campus must provide a copy of the Plan to the chief executive officer of the municipality or municipalities in which the proposed Tax-free NY Area is located, local economic development entities, the applicable university or college faculty senate, union representatives and the campus student government. The campus shall include in their submission to the Commissioner of Economic Development certification of such notification, as well as a copy of any written response from chief executive officer of the municipality or municipalities in which the proposed Tax-free NY Area is located, local economic development entities, the applicable campus or college faculty senate, union representatives and the campus student government.

[StartUp-NY.gov](#) website and program information.

Procedures

[START-UP NY Program Participation, Procedures for](#)

Forms

[SUNY START-UP NY Campus Plan for Designation of Tax-Free Area\(s\) Memorandum](#)

[SUNY START-UP NY Campus Plan for Designation of Tax-Free Area\(s\) Template](#)

[START-UP NY Sponsoring University or College Application for Business Participation Memorandum](#)

[ESD START-UP NY Sponsoring University or College Application for Business Participation](#)

[ESD START-UP NY Business Application Instructions](#)

[ESD START-UP Business Application](#)

Authority

[State University of New York Board of Trustees Resolution 14-\(\) . START-UP New York Program Administration, adopted January 14, 2014](#)

[Law, New York Economic Development Law Article 21 \(Start-Up NY Program\)](#)

[Start-Up NY Regulations](#)

History

Enacted into law in June 2013, START-UP NY is a groundbreaking new initiative from Governor Andrew M. Cuomo that provides major incentives for businesses to relocate, start up or significantly expand in New York State through affiliations with public and private universities, colleges and community colleges. Businesses will have the opportunity to operate state and local tax-free on or near academic campuses, and their employees will pay no state or local personal income taxes.

Appendices

There are no appendices relevant to this policy.



195 Cohoes Avenue
Green Island, NY 12183



Total Square Feet 28,800

HVCC Downtown Troy

Start-Up NY Unique ID

SU-315-2-B-T2195-000-U

Troy, NY 12183, USA



TFA

195 Cohoes Avenue
Green Island NY

© 2014 Google

Google earth

9/18/2014

TOTAL SQUARE FEET 28,800

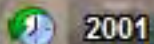

42°45'24.67" N 73°41'32.91" W elev 65 ft eye alt 415 ft

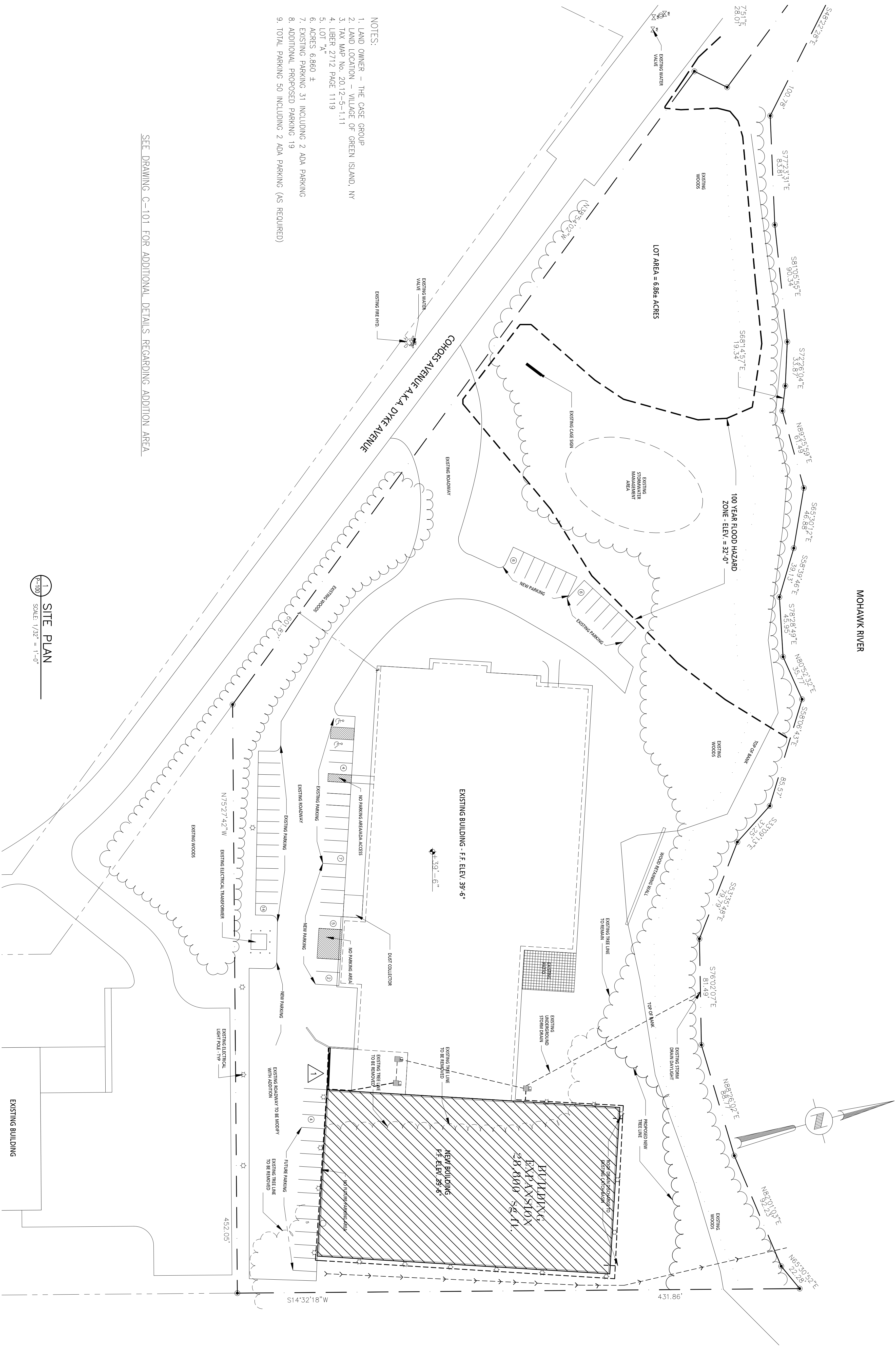

- NOTES:
1. LAND OWNER - THE CASE GROUP
 2. LAND LOCATION - VILLAGE OF GREEN ISLAND, NY
 3. TAX MAP No. 20.12-5-1.11
 4. UBER 2712 PAGE 1119
 5. LOT "A"
 6. ACRES 6.860 ±
 7. EXISTING PARKING 31 INCLUDING 2 ADA PARKING
 8. ADDITIONAL PROPOSED PARKING 19
 9. TOTAL PARKING 50 INCLUDING 2 ADA PARKING (AS REQUIRED)

SEE DRAWING C-101 FOR ADDITIONAL DETAILS REGARDING ADDITION AREA

SITE PLAN
SCALE: 1/32" = 1'-0"

EXISTING BUILDING

No.	Date	Revision	By
1	06-07-2013	ISSUED FOR PERMIT	PM
2			
3			
4			

Scale: As Noted
Date: 06-07-2013
Drawn by: PM
RA Stamp

Sheet Title:
SITE PLAN

Disclaimers:

Project Title:
**The CASE Group, LLC
Plant Expansion - Phase III**

Architect:
Pasquale Marchese, AIA-LEED AP BD+C

195 Cohoes Avenue
Green Island, NY
12183

The Case Group, LLC · 195 Cohoes Ave. · Green Island, NY 12183
Phone: 518.720.3100 · Fax: 518.720.3110 · 1.800.227.3957

CASE
Window and Door
Consultants:

Drawing Name:
C3 - FP 014
Scale:
3/32" = 1'

Drawing Description:
Case Phase III - Development Floor Plan 014
195 Cohoes Avenue Green Island, NY 12183

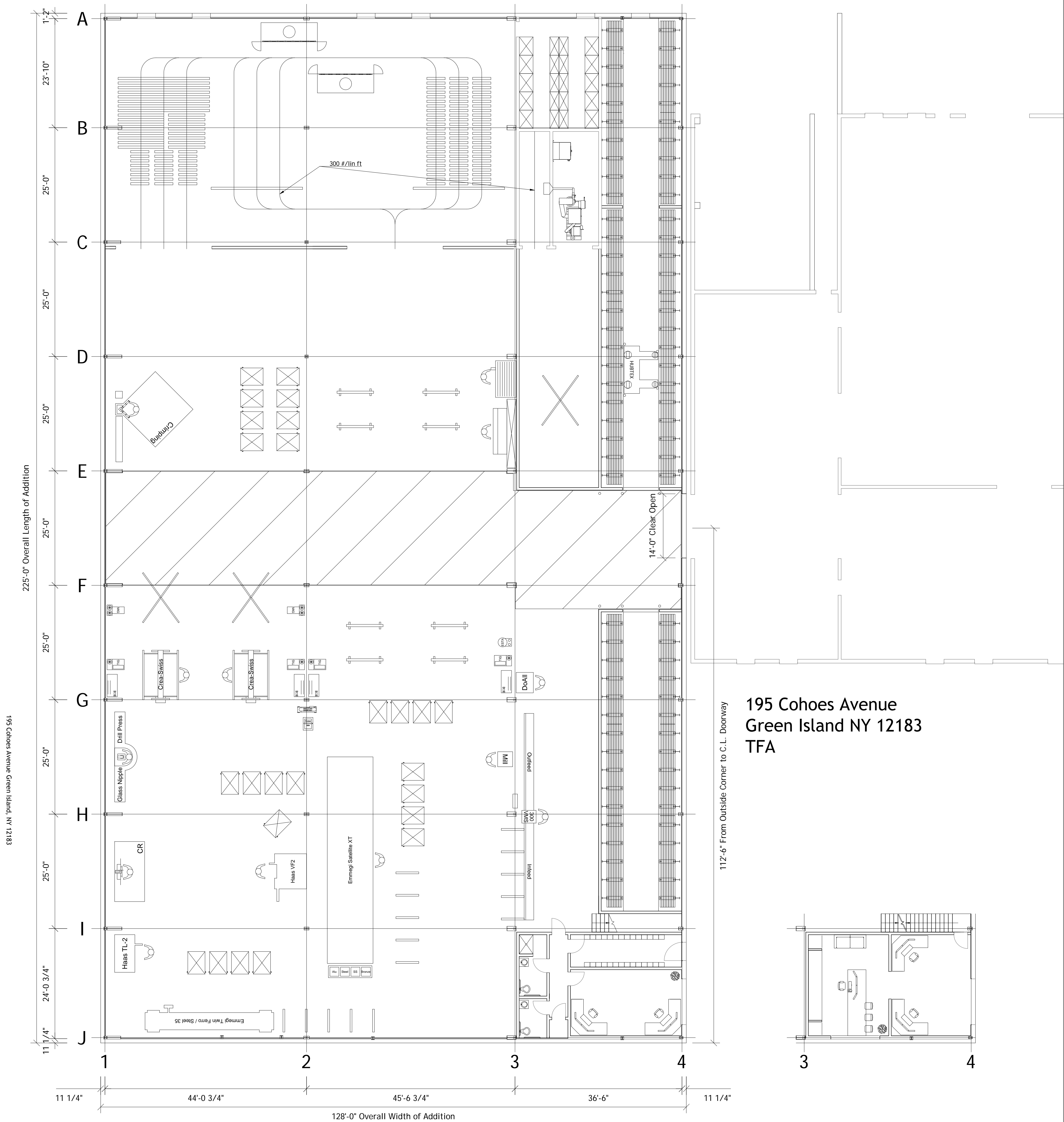
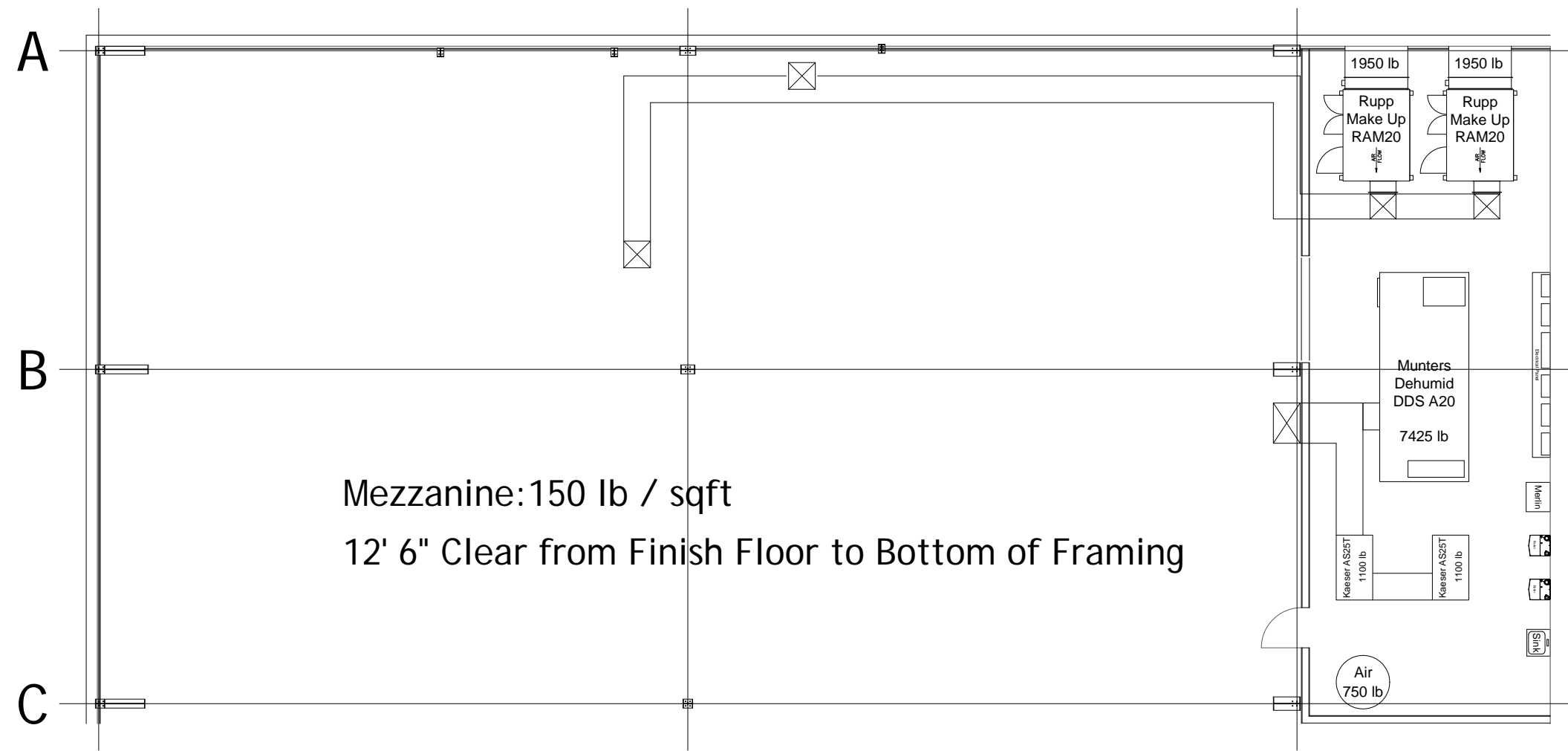

195 Cohoes Avenue
Green Island NY 12183
TFA

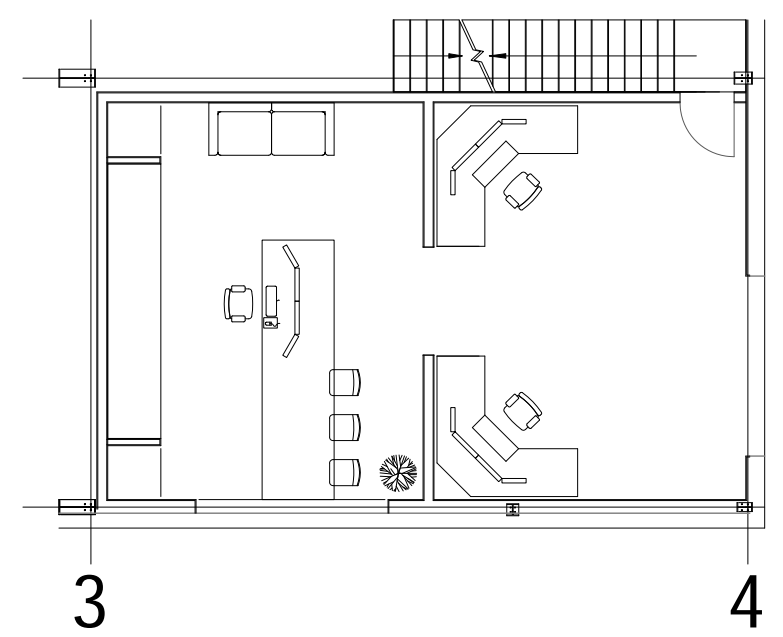

HVCC Downtown Troy

Unique ID SU-315-2-B-T2075-000-A



18,036 square feet

Ross Building
75 102nd Street
Troy NY 12180

View facing west

2/22/2017

Google earth

2004

42°45'25.35" N 73°40'31.25" W elev 68 ft eye alt 264 ft

HVCC Downtown Troy

Unique ID SU-315-2-B-T2075-000-A

Ross Building
75 102nd Street
Troy NY 12180

18,036 square feet

© 2014 Google
view facing south

2/22/2017

Google earth

2004

42°45'27.87" N 73°40'31.82" W elev 63 ft eye alt 304 ft

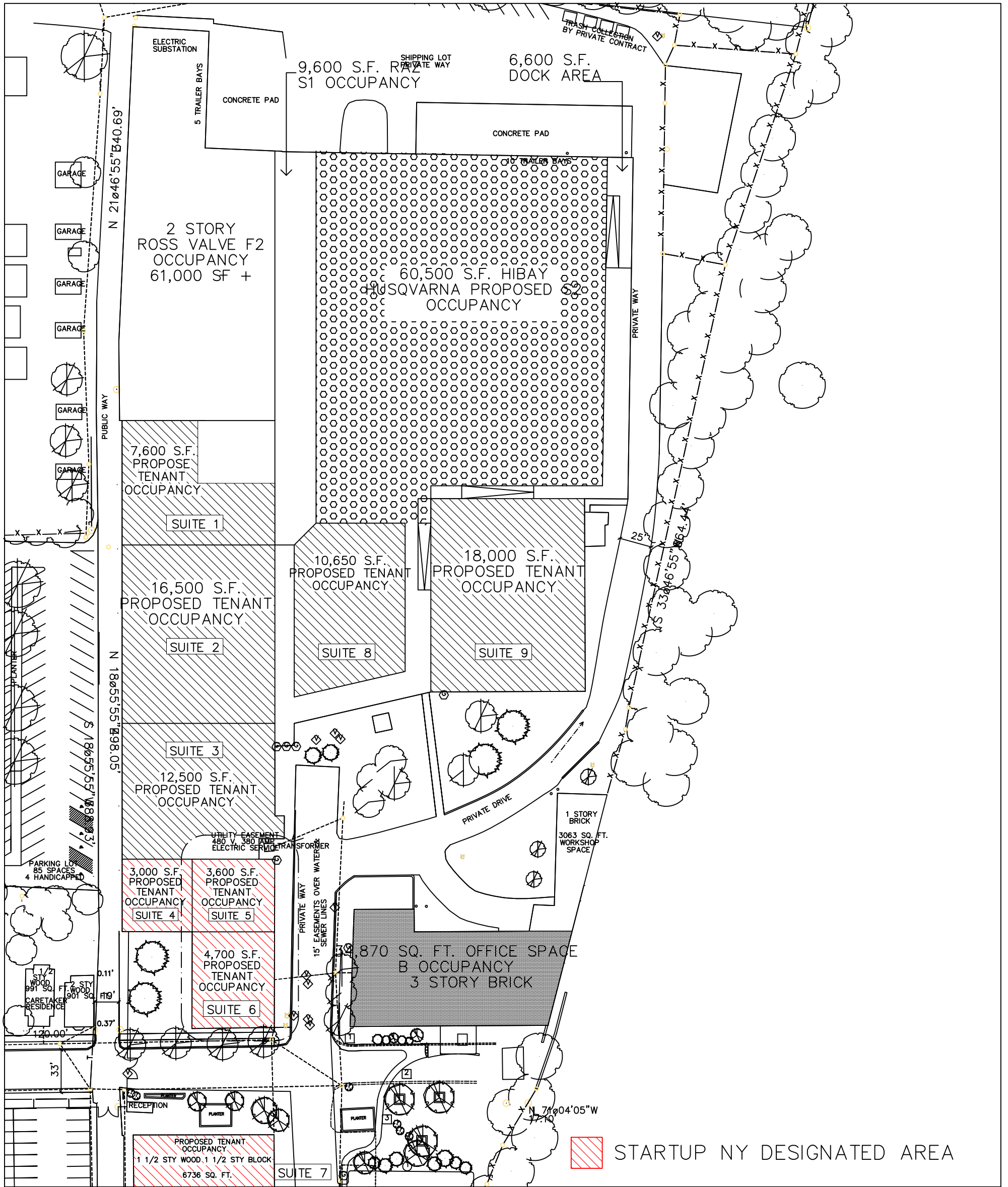

ROSS TECHNOLOGY PARK
FEBRUARY 15, 2017

75 102ND STREET
TROY, NY 12180

18,036 SQUARE FEET



Designated Space for



1 View Southeast from 3rd St.

1. Construct appropriate storefront in character with building.
2. Accent ground floor structural rhythm with columns enclosures.
3. Develop entrances at Broadway east end and middle of 3rd St.
4. Restore facades and windows of upper floors .
5. Repair slate mansard as required.

Proposed Improvements for the
Quackenbush Building
2006 Renderings
@ 3rd & Broadway

Troy, New York
 Prepared March 12, 2006
 Revised -/-

A1.P



297 River St., Troy, NY 12180 518.274.7777



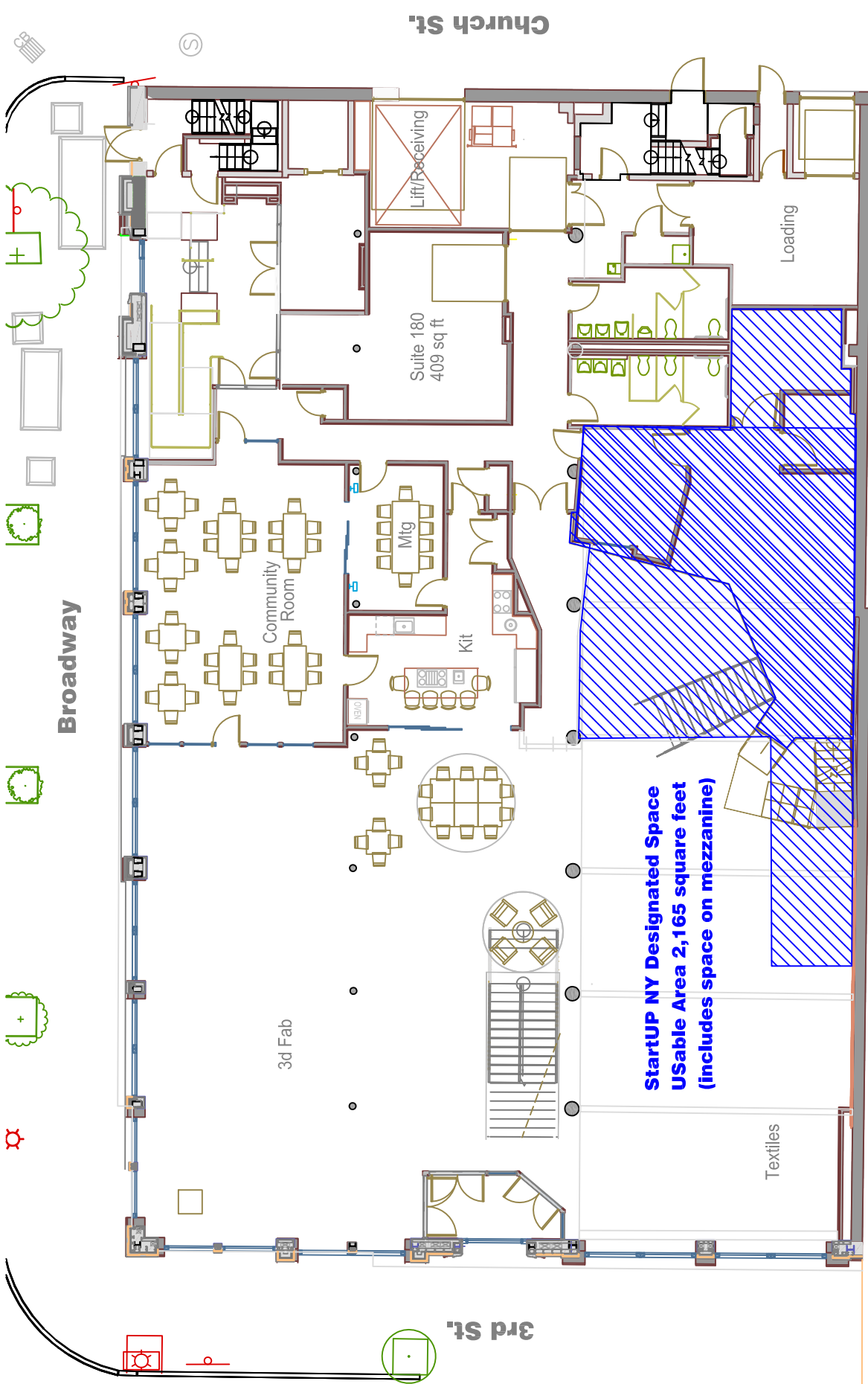

First Floor Total 2,165 Square Feet

1 First Floor Plan

1. Improve ground level facade with new storefront and stone facing.
2. Recreate historic scale and rhythm of the ground floor facade.
3. Construct overhead door at Church St. for ramp to basement.
4. Develop upscale accessible elevator lobby and first floor access.
5. Large open space with abundant natural light.

Designated Space for



Proposed Improvements for the
Quackenbush Building
Schematic Tenant Layout
@ 3rd & Broadway

Troy, New York
 Prepared June 1, 2014
 Revised August 27, 2014

A1.1



ARCHITECTURAL DEVELOPMENT 297 River St., Troy, NY 12180 518.274.7777

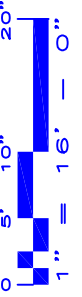

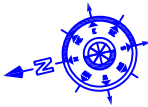

Broadway

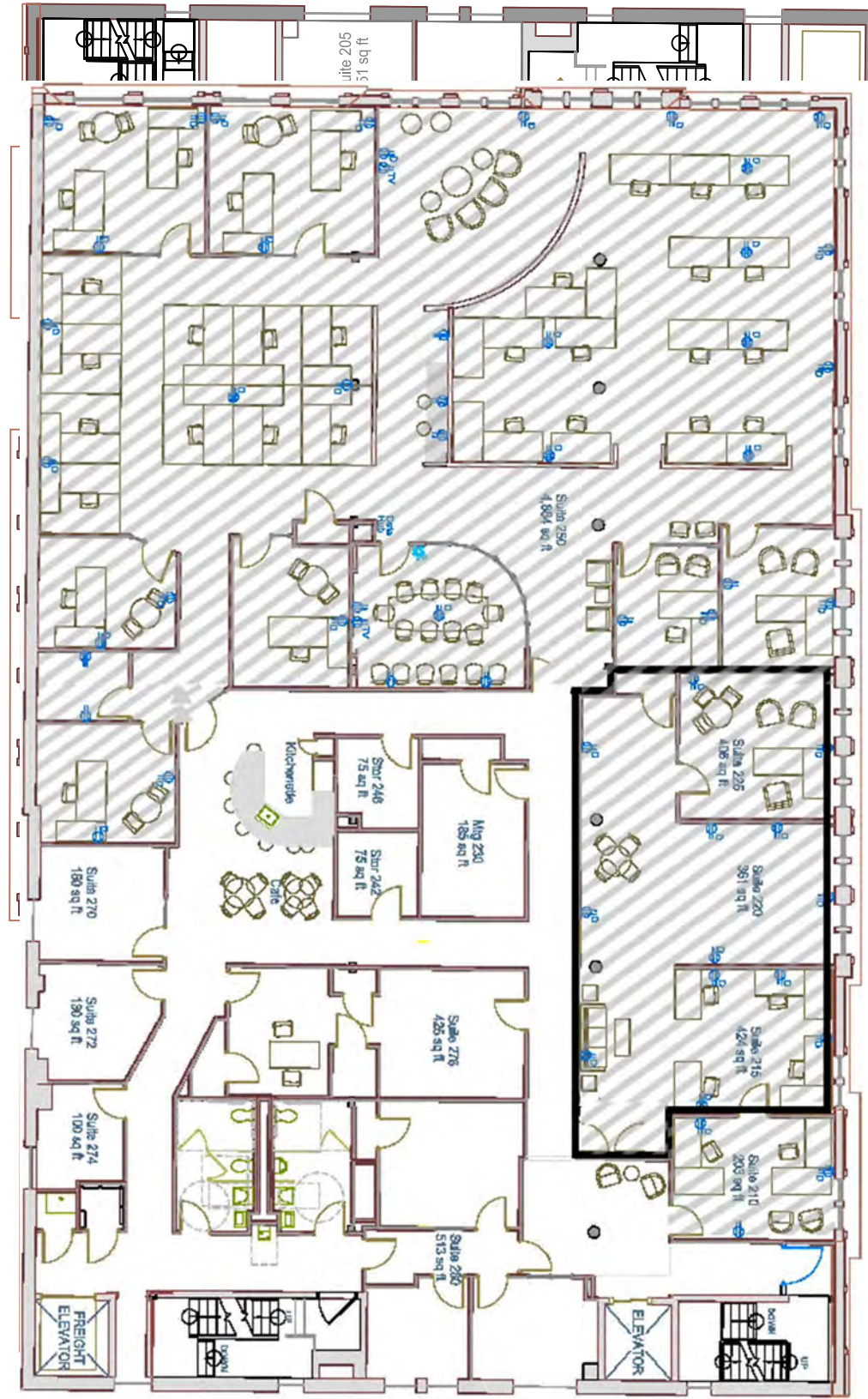

Church St.

3rd St.

Second Floor Total **6,278** Square Feet

1 Second Floor Plan

1. Develop business service center - SPECTRUM™ - with rentable suites.
2. Develop vertical connection between the Center of Gravity & 2nd floor.
3. Develop floor plan to maximize expansive windows.
4. Insure space can be easily retrofit for commercial tenants.

Designated Space for



Proposed Improvements for the
Quackenbush Building
Schematic SPECTRUM Layout
@ 3rd & Broadway

Troy, New York

Prepared June 1, 2014

Revised October 28, 2015

A1.2



ARCHITECTURAL DEVELOPMENT 237 River St., Troy, NY 12180 515.274.7777

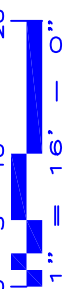

11/16/2021

Church St.

Broadway

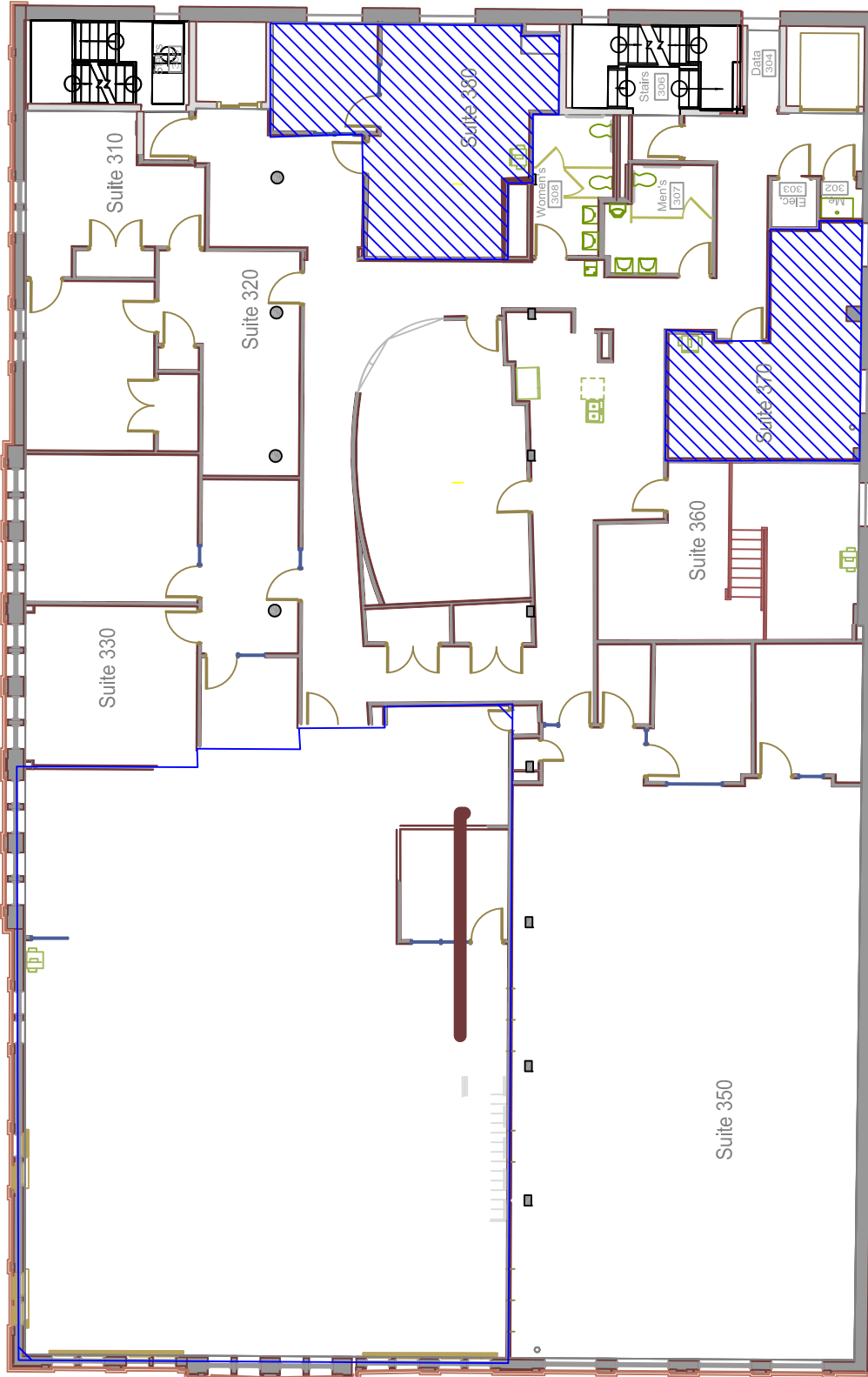

Total Square Feet

3rd St.

OFF-CAMPUS Suites 370, 380 = 906 sq.ft.

Third Floor Plan

1

1. Rens. County IDA Floor with their office in NE corner.
2. IDA Board room at center - has teleconferencing equipment.
3. Develop spaces around expansive windows.
4. Mechanical thermal shades on rehabilitated historic windows.
5. Operable windows offer green ventilation and abundant light.

Designated Space for



**Proposed Improvements for the
Quackenbush Building
Schematic Tenant Layout
@ 3rd & Broadway**

A1.3

Troy, New York
Prepared June 1, 2014
Revised May 11, 2016



297 River St., Troy, NY 12180 518.274.7777



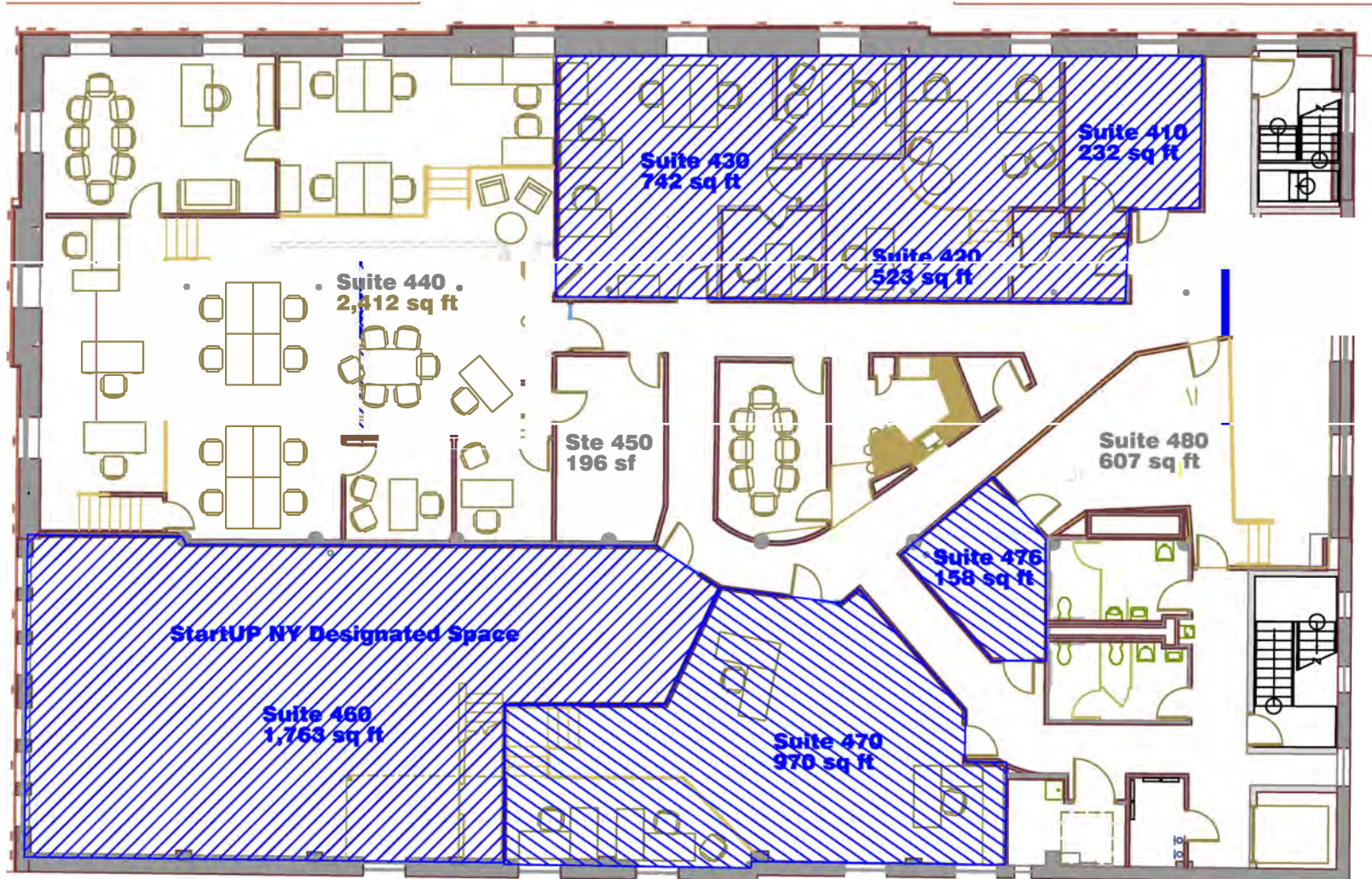

1 Fourth Floor Plan

1. Deep window sill, big views and Victorian column brackets.
2. Elevate floor for mechanicals and to adjust floor to window sill height.
3. Open floor plan with loft feel.
4. Locate ventilation shafts through floor for use below.

Proposed Improvements for the
Quackenbush Building
Schematic Tenant Layout
@ 3rd & Broadway

Troy, New York
 Prepared June 14, 2014
 Revised: September 16, 2018

A1.4

Designated Space for

STARTUP NY

4,388 square feet

October 1, 2018



297 River St., Troy, NY 12180 318.274.7777

HVCC DOWNTOWN

500 Federal Street
Troy, NY 12020

StartUP NY Unique ID SU-315-2-B-T2500-002-A

StartUP NY Unique ID SU-315-2-B-T2500-004-A



Total Tax Free Area 7,406



12/13/17



HVCC DOWNTOWN

500 Federal Street
Troy, NY 12020

StartUP NY Unique ID# SU-315-2-B-T2500-00G-A

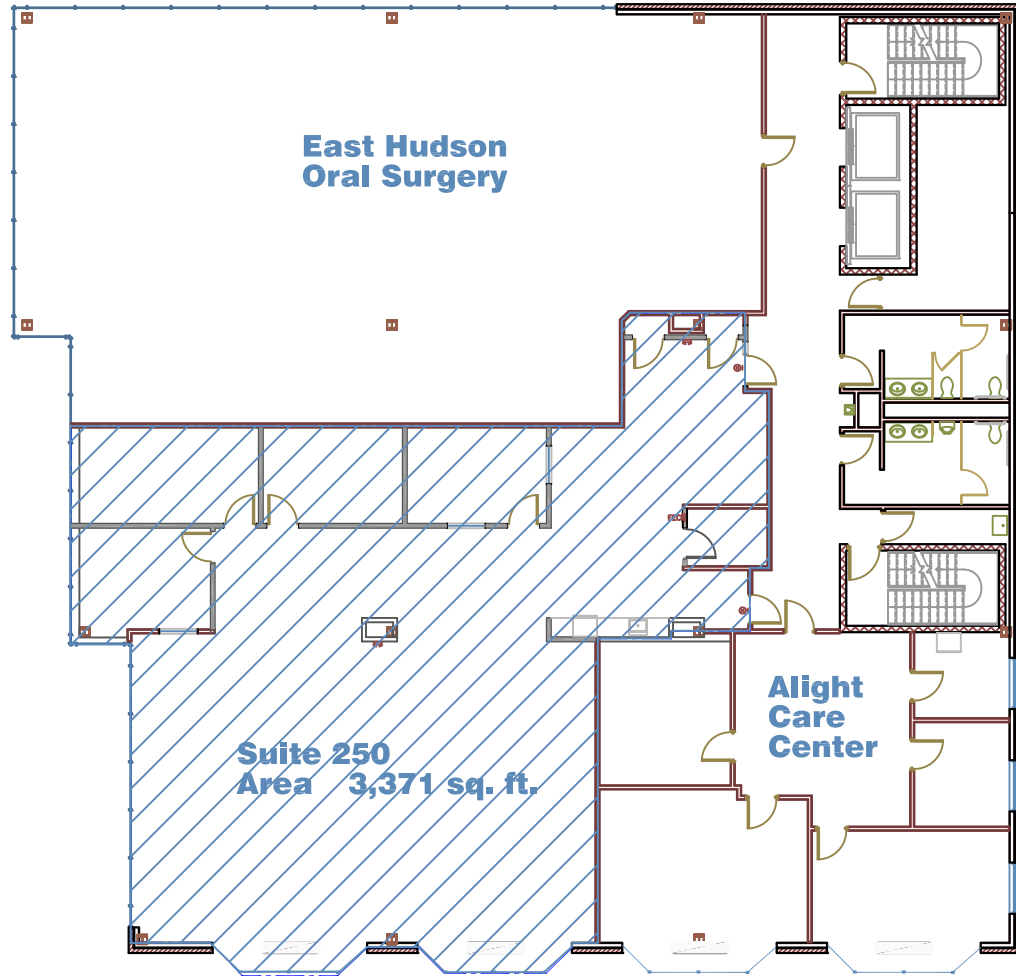

Total Tax Free Area 3,371

1 SECOND FLOOR PLAN

1. Construct three offices and a conference room.
2. Develop layout with tenant and construct to tenant specifications.
3. Space to be painted to tenant specifications.



Proposed Improvements for the
Child Care Center Software
at
500 Federal St.

BRYCE



297 River St., Troy, NY 12180 518.274.7777

Troy, New York
Prepared May 8, 2017
Revised -/-

Ex. A



Federal St.

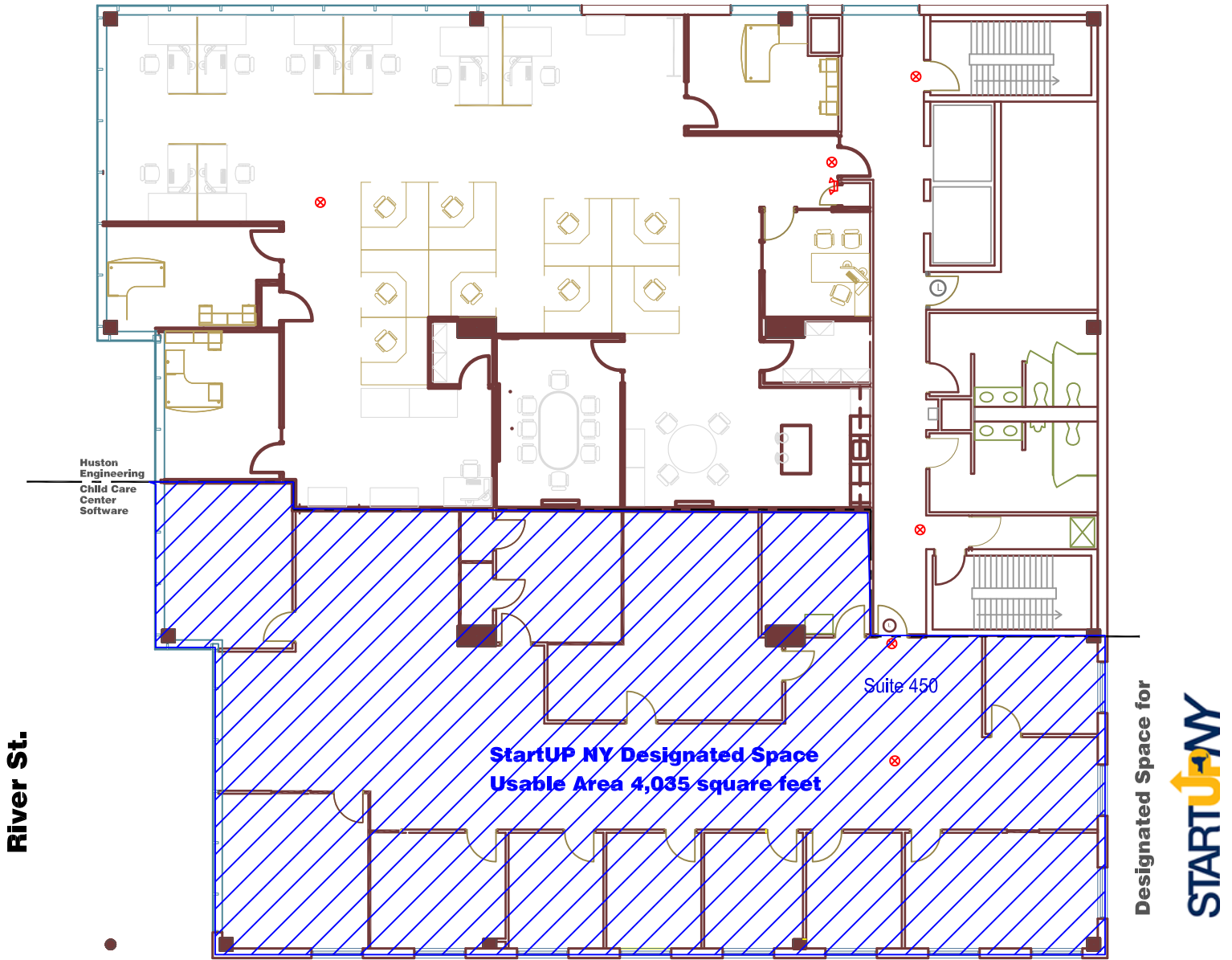

1 **Fourth Floor Plan**

- 1.-
- 2.-
- 3.-
- 4.-
- 5.-

Total Tax Free Area 4,035

02/23/17

Proposed Improvements for the
500 Federal St.
Schematic Tenant Layout
@ River St. & Federal St.

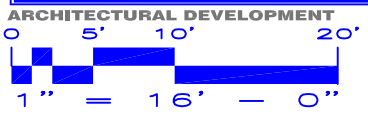

ARCHITECTURAL DEVELOPMENT 297 River St., Troy, NY 12180 518.274.7777

Troy, New York
 Prepared February 16, 2017
 Revised -/-

A1.4



Exhibit "A2"

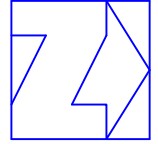

CALLED NORTH

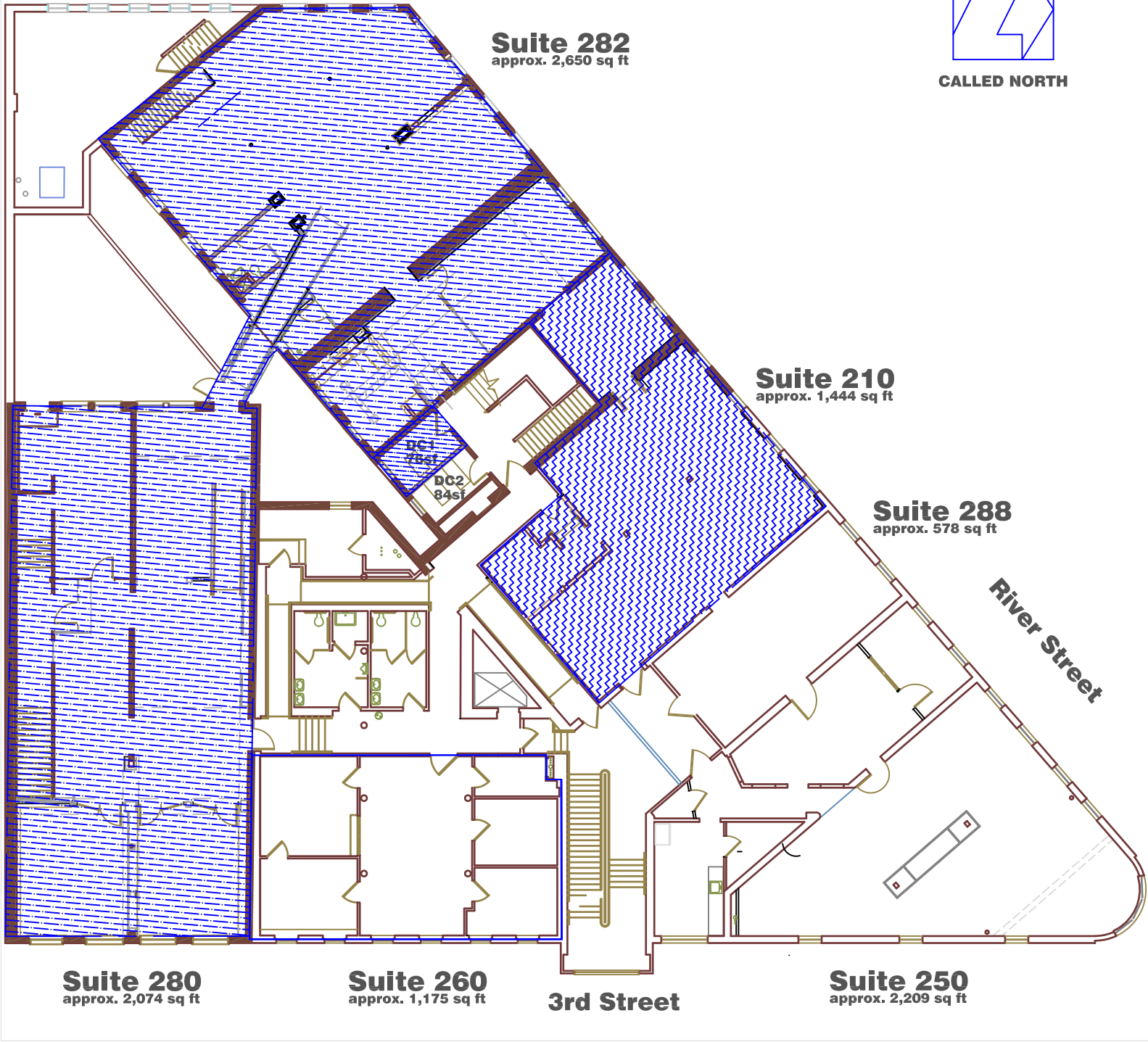

Tax Free Area 6,168 Sq. Ft.

**MARKET BLOCK
5 Third St.
Second Floor
Troy, NY 12180**

October 1, 2018

Exhibit "A3"

HVCC DOWNTOWN

StartUP NY Unique ID SU-315-2-B-T205-003-A

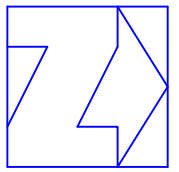

CALLED NORTH

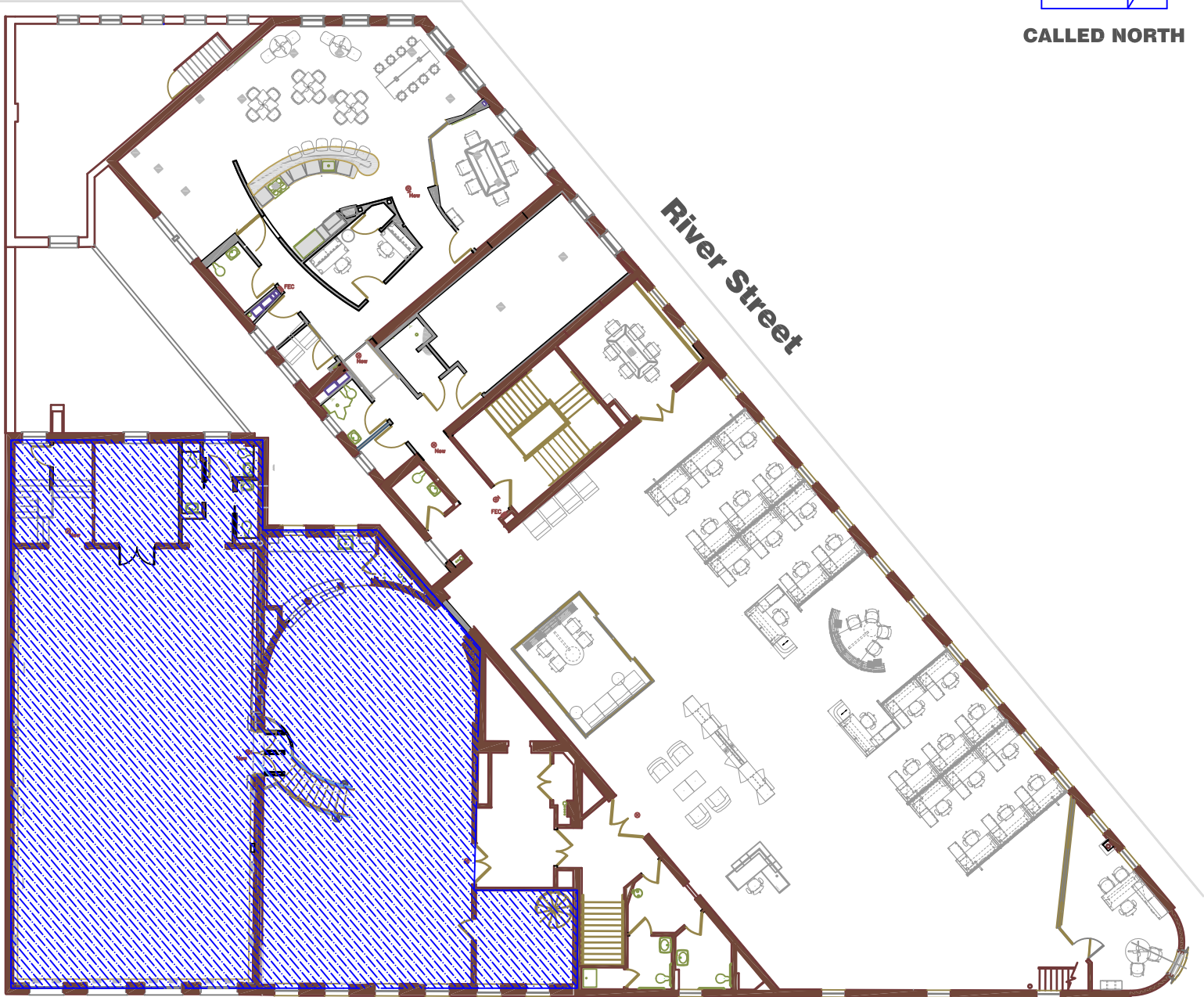

Main Floor Area
4,569 sq ft

Third Street

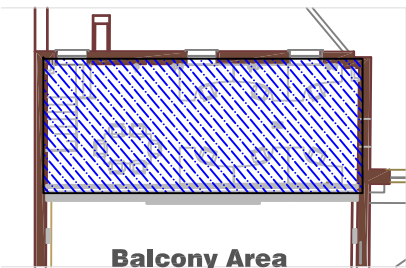

Balcony Area
490 sq ft



Treehouse Area
584 sq ft

Total Tax Free Area 5,643

MARKET BLOCK Third Floor

11/27/17

[Type here]

HVCC DOWNTOWN TROY
Frear Building
2 Third St, Troy, NY 12180

StartUP NY Unique ID's by floor:
SU-315-2-B-T2002-002-A
SU-315-2-B-T2002-003-A



Building Total 8,230 Square Feet

HVCC DOWNTOWN TROY
Frear Building
2 Third St, Troy, NY 12180

StartUP NY Unique ID's by
floor: SU-315-2-B-T2002-002-A



Second Floor Total 4,458 Square Feet

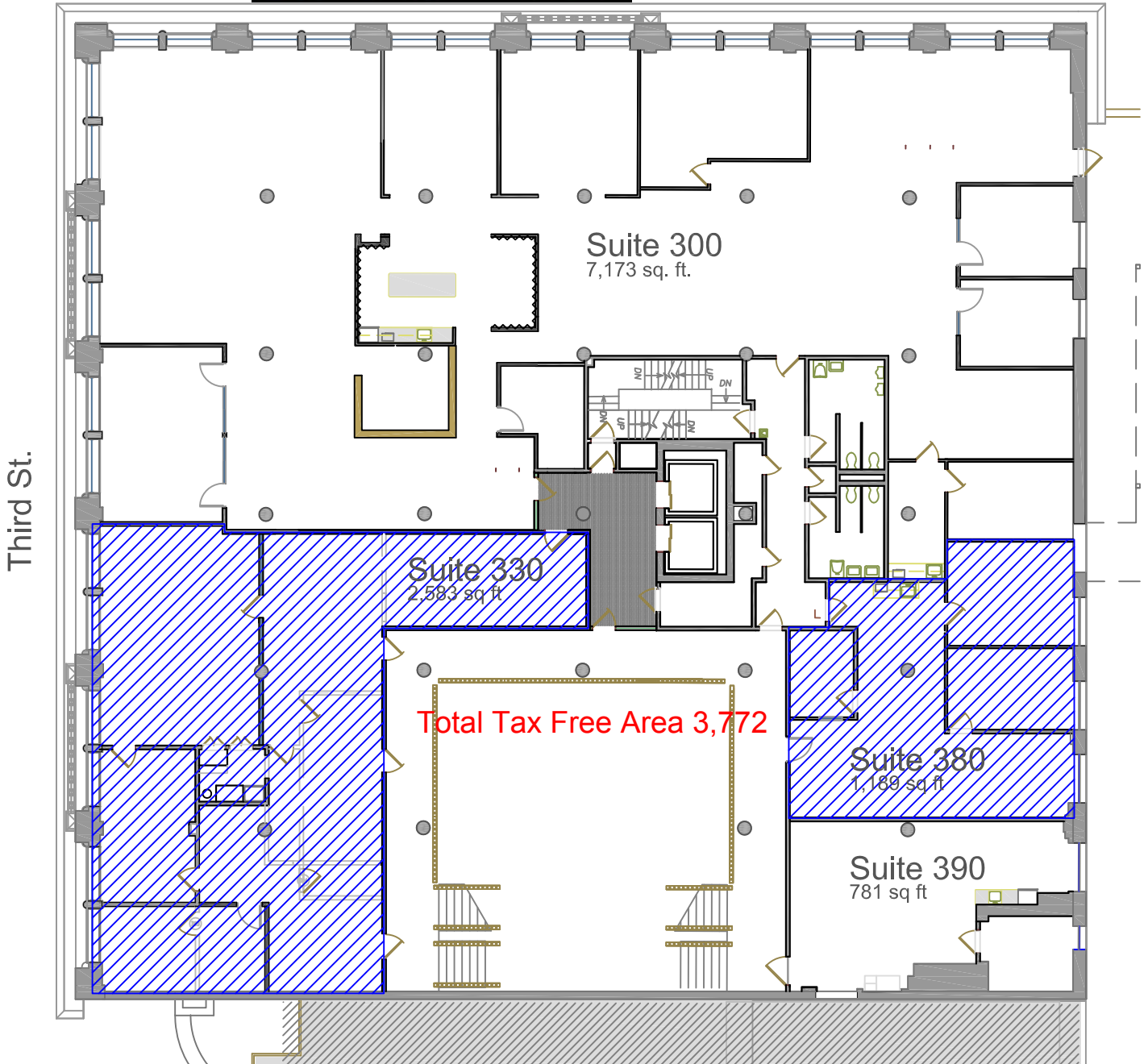

1

Third Floor Plan

- 1. Originally fit out for the US Veterans Admin in 1987.
- 2. Suite 300 containing 7,173 sq ft is occupied by X5
- 3. Suite 330, containing 2,583 sq. ft., is vacant.
- 4. Suite 380, containing 1,189 sq. ft., is currently vacant.
- 5. Suite 390, Containing 781 sq. ft., was formerly the NYS DOH lunch room.
- 6. Most rooms have individual temperature controls.
- 7. All spaces have easy access to wiring and can be independant.

2 Third Street Troy, NY

BRYCE

Tax Free Area 3,772

11/27/17

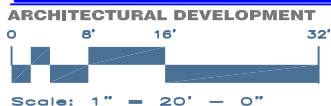

ARCHITECTURAL DEVELOPMENT 297 River St., Troy, NY 12180 518.274.7777

Troy, New York
Prepared March 12, 2017
Last Revised -/-

A1.3

HVCC DOWNTOWN

StartUP NY Unique ID SU-315-2-B-T2291-002-A

291 River Street
Second Floor
Troy, NY 12180



TROY CLOTH & PAPER
FINE STATIONERY ART & APPAREL
ECO-FRIENDLY SCREEN PRINTING

291

02/23/17

Total Tax Free Area 1,435



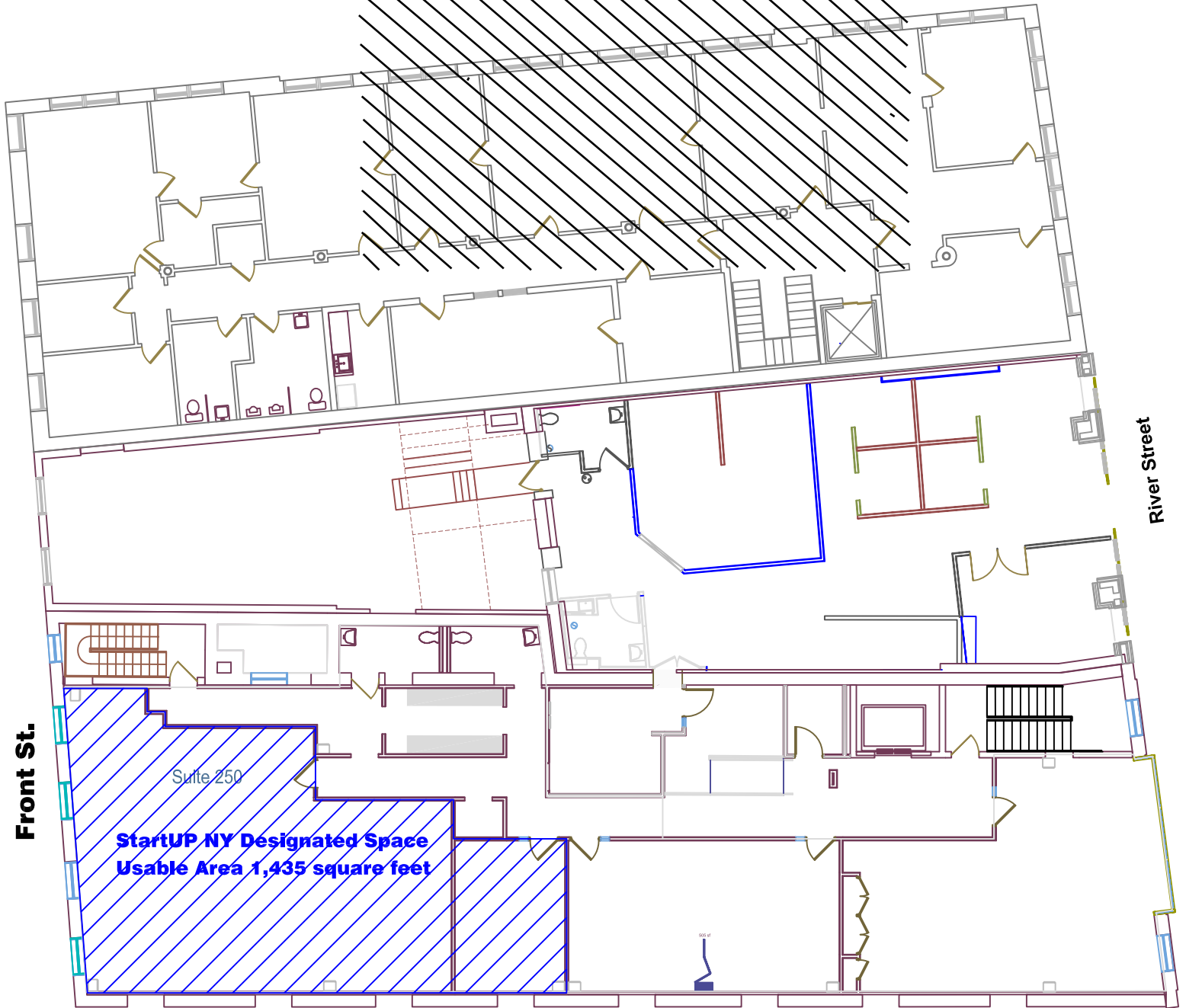

1 **Second Floor Plan**

- 1. -
- 2. -
- 3. - **Total Tax Free Area 1,435**
- 4. -
- 5. -

BRYCE



ARCHITECTURAL DEVELOPMENT 297 River St., Troy, NY 12180 518.274.7777

02/23/17

Proposed Improvements for the
291 River St.
Designated Space
@ River St. & 3rd St.

Troy, New York
 Prepared February 16, 2017
 Revised -/-

STARTUP-NY

A1.2

35 Fourth Street
Troy, NY 12180



January 25, 2017



IT IS A VIOLATION OF LAW FOR ANY PERSON, UNLESS THEY ARE ACTING UNDER THE DIRECTION OF A LICENSED PROFESSIONAL ENGINEER, ARCHITECT, LANDSCAPE ARCHITECT, OR LAND SURVEYOR, TO ALTER AN ITEM IN ANY WAY. IF AN ITEM BEARING THE STAMP OF A LICENSED PROFESSIONAL IS ALTERED, THE ALTERING ENGINEER, ARCHITECT, LANDSCAPE ARCHITECT, OR LAND SURVEYOR SHALL STAMP THE DOCUMENT AND INCLUDE THE NOTATION "ALTERED BY" FOLLOWED BY THEIR SIGNATURE, THE DATE OF SUCH ALTERATION, AND A SPECIFIC DESCRIPTION OF THE ALTERATION.

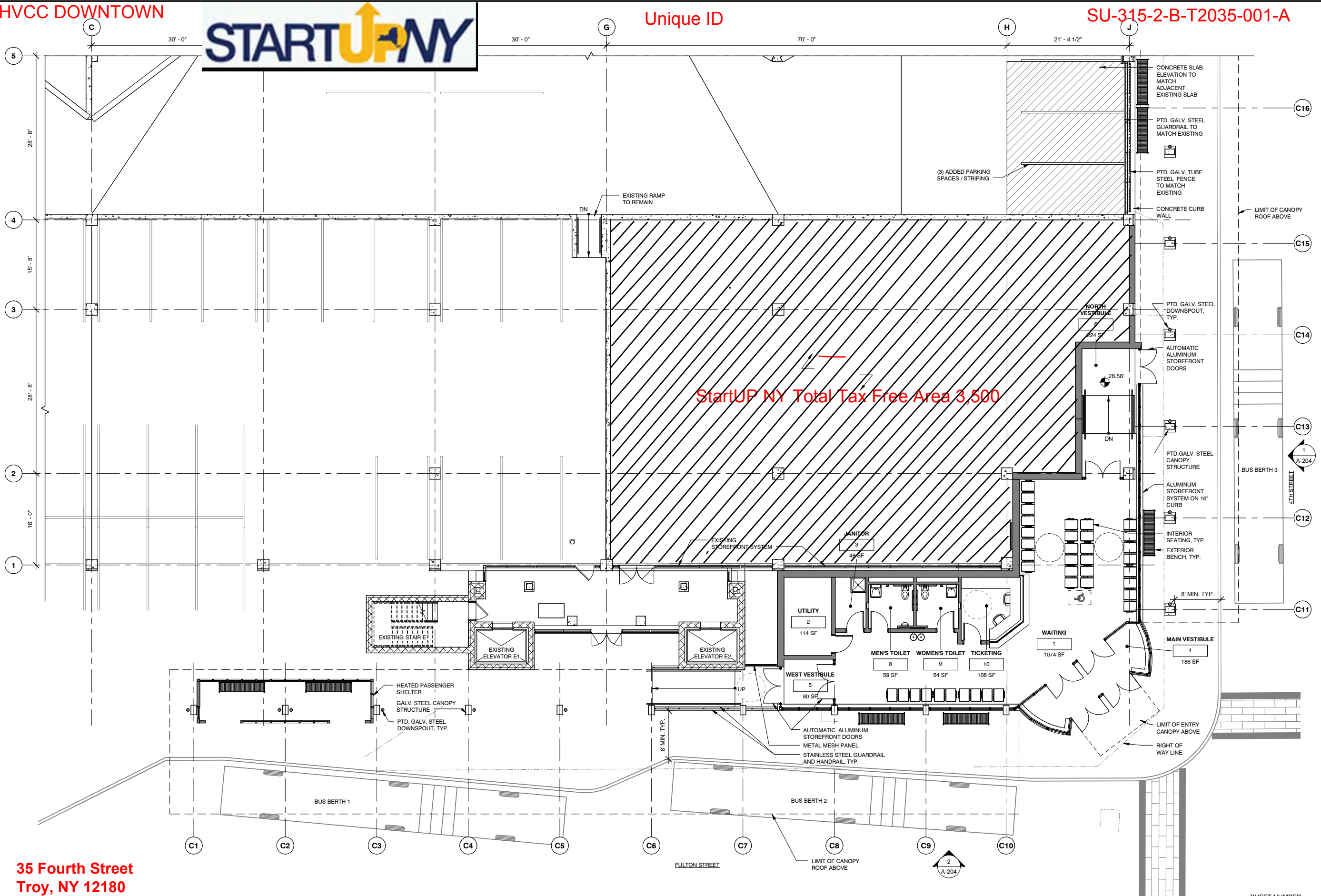

StartUP NY Total Tax Free Area 3,500

35 Fourth Street
Troy, NY 12180

1 SK-01 TRANSIT CENTER FLOOR PLAN - ALT 1
SCALE: 1/8" = 1'-0"

Total Tax Free Area 3,500

03/17/17

PREPARED FOR: Capital District Transportation Authority 110 Watervliet Avenue Albany, New York 12206	NO.	REVISION	DATE	BY
	PROGRESS PRINT NOT FOR CONSTRUCTION			
CREDITON MANNING SOWINSKISULLIVAN ARCHITECTS	DESIGNED/Designer	DRAWN BY: Author	CHECKED: Checker	
	DATE: APR 2016	CM No.: 115-201	SCALE: AS NOTED	
CDTA RIVER CORRIDOR BRT IMPROVEMENTS FOR UNCLE SAM TRANSIT CENTER TROY, NEW YORK	TRANSIT CENTER FLOOR PLAN			
SK-01				

FILE = C:\Users\bkovala\Documents\263356_A_v16_bkova.rvt
DATE = 6/23/2016 2:51:47 PM
USER = \$RVTOUSER\$

StartUp NY Unique ID: SU-315-2-B-2274-001-A

SU-315-2-B-2274-002-A

HVCC Downtown Troy



**274 Second Street
Troy NY 12180**



Total Tax Free Area 13,558

2/23/2017

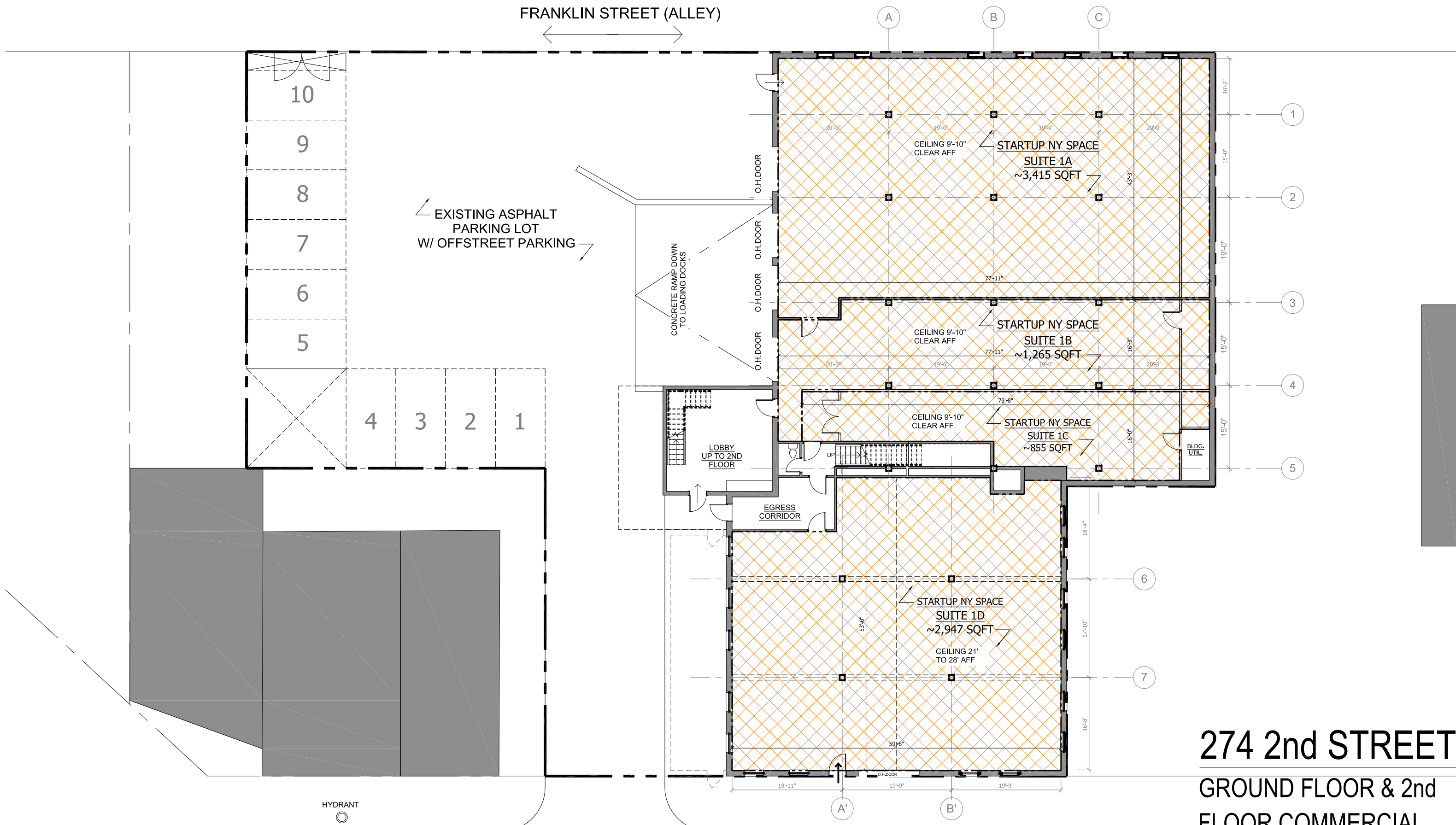

FRANKLIN STREET (ALLEY)

EXISTING ASPHALT
PARKING LOT
W/ OFFSTREET PARKING

CONCRETE RAMP DOWN
TO LOADING DOCKS

LOBBY
UP TO 2ND
FLOOR

EGRESS
CORRIDOR

STARTUP NY SPACE
SUITE 1A
~3,415 SQFT

STARTUP NY SPACE
SUITE 1B
~1,265 SQFT

STARTUP NY SPACE
SUITE 1C
~855 SQFT

STARTUP NY SPACE
SUITE 1D
~2,947 SQFT

CEILING 21'
TO 28' AFF

CEILING 9'-10"
CLEAR AFF

CEILING 9'-10"
CLEAR AFF

CEILING 9'-10"
CLEAR AFF

274 2nd STREET - 1st FLOOR

2ND STREET

274 2nd STREET

GROUND FLOOR & 2nd

FLOOR COMMERCIAL

TROY, NY 12180

SCALE : 1/16" = 1'-0" @ 11x17

SU-315-2-B-T2274-001-A

BUILDING TOTAL: ~13,558 SQFT

1ST FLOOR: ~8,482 SQFT



North

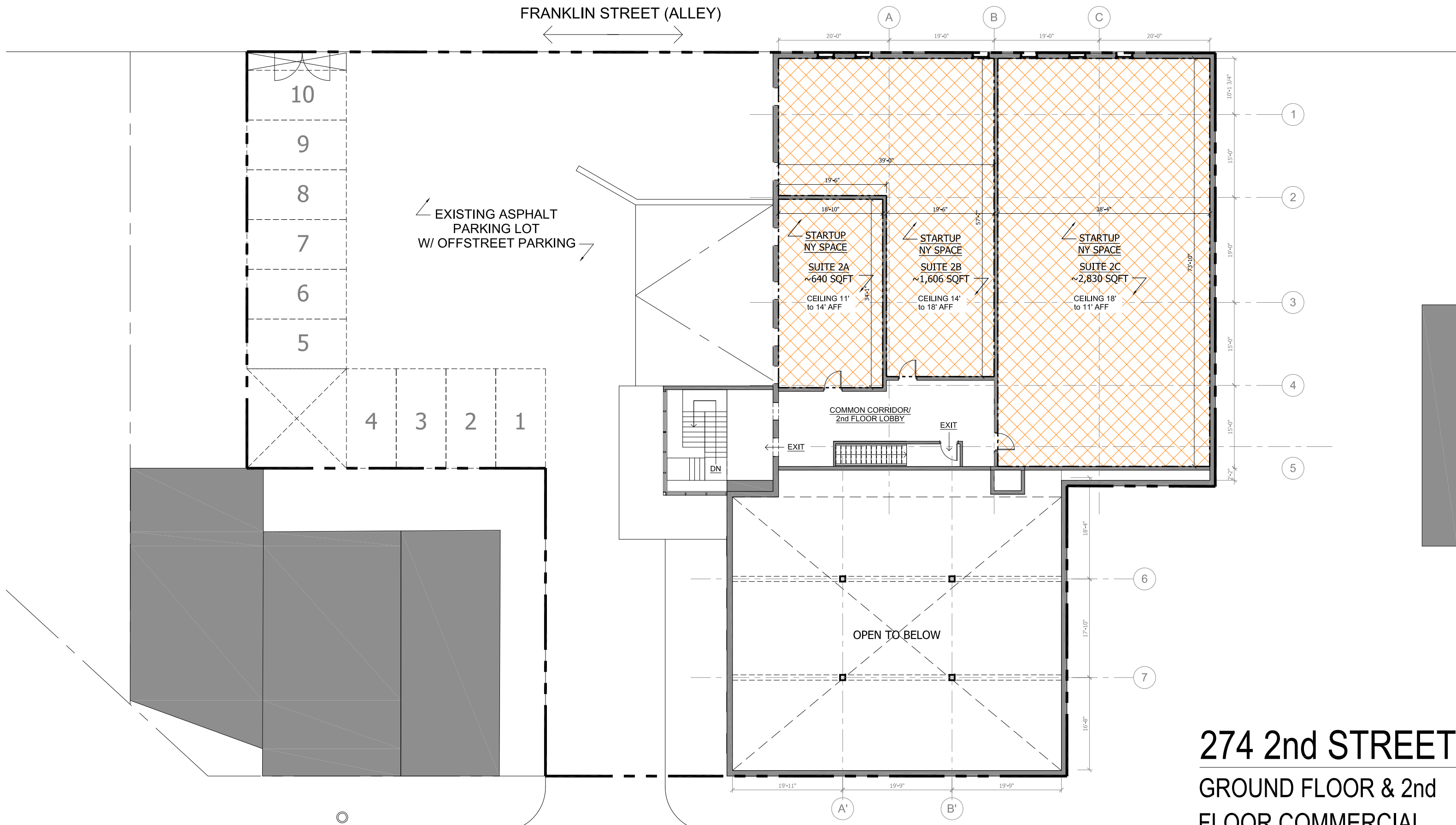

FRANKLIN STREET (ALLEY)

EXISTING ASPHALT
PARKING LOT
W/ OFFSTREET PARKING

COMMON CORRIDOR/
2nd FLOOR LOBBY

OPEN TO BELOW

2ND STREET

274 2nd STREET
GROUND FLOOR & 2nd
FLOOR COMMERCIAL
TROY, NY 12180

2ND FLOOR: ~5,076 SQFT

274 2nd STREET - 2nd FLOOR

2

A2

SCALE : 1/16" = 1'-0" @ 11x17

SU-315-2-B-T2274-002-A

BUILDING TOTAL: ~13,558 SQFT



North



275 Fourth Street Troy, NY

Total Tax Free Area 990 sq.ft.

03/17/17

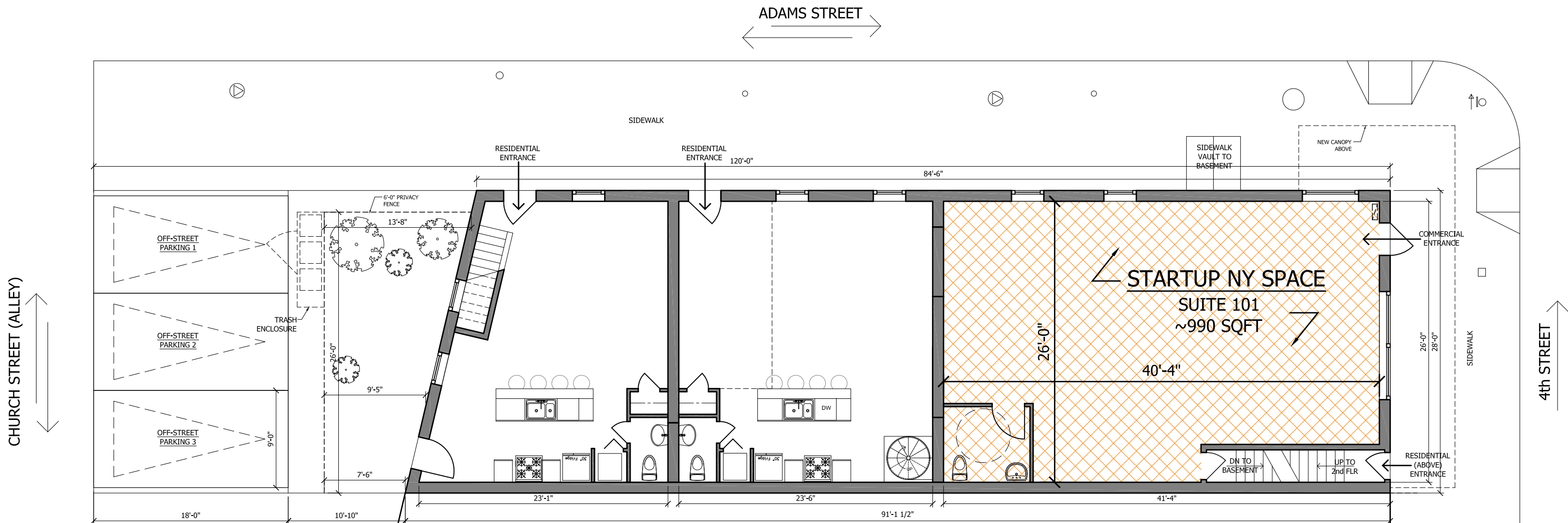

275 4th STREET
 GROUND FLOOR COMMERCIAL
 TROY, NY 12180
 SUITE 101: ~990 SQFT



ZONING: R-4
 TAX ID: 101.77-8-5



Total Tax Free Area 990 sq.ft.

03/17/17

HVCC

StartUp NY Unique ID SU-315-2-B-T2225-002-A

StartUp NY Unique ID SU-315-2-B-T 2225-003-A



Sentinel Building 225 River Street, 2nd and 3rd Floor Troy 12180



Total Square Feet Building 2,600

2/24/2017

HVCC

StartUp NY

Unique ID SU-315-2-B-T2225-002-A

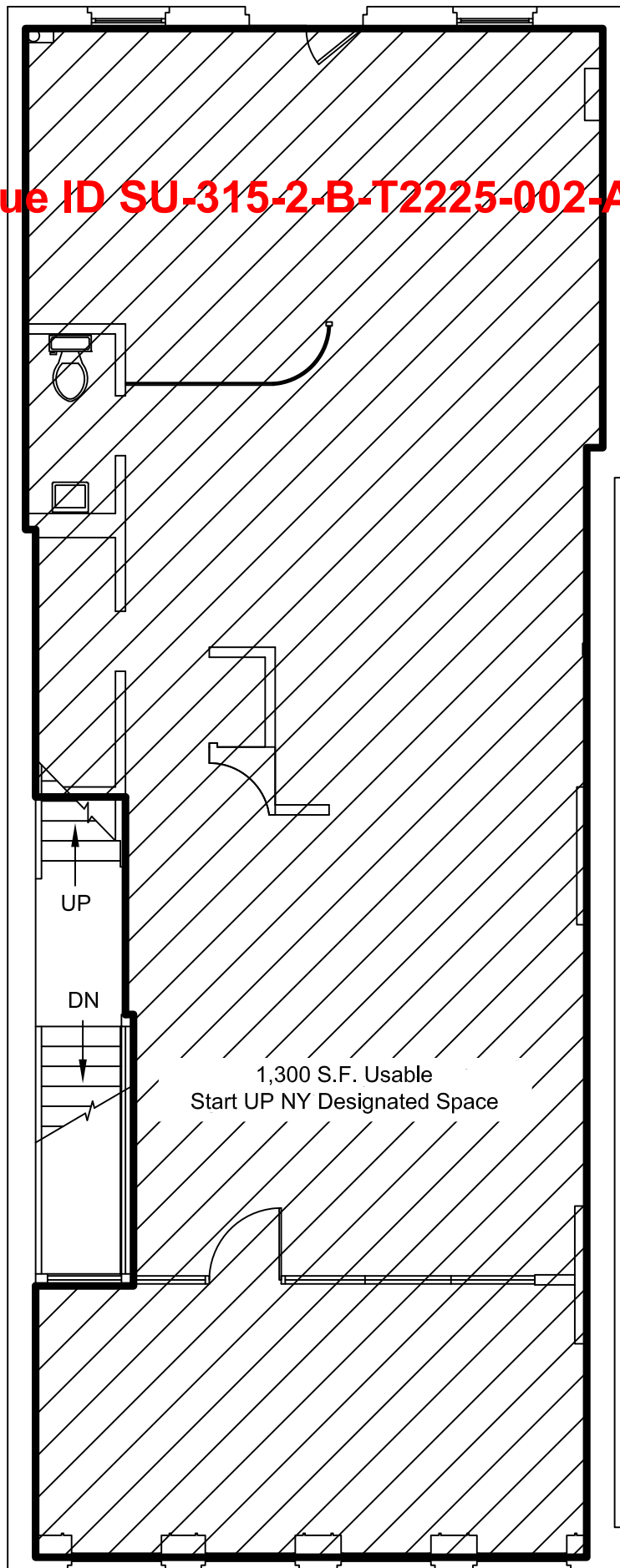

Total Square Footage 1,300

225 RIVER STREET
TROY, NY
2ND FLOOR



JUDGE
Development Corp.

255 RIVER STREET
TROY, NY 12180
P. 518-274-3325
F. 518-274-4833

<<06/28/2016>>

Unique ID SU-315-2-B-T2225-003-A

HVCC

StartUp NY

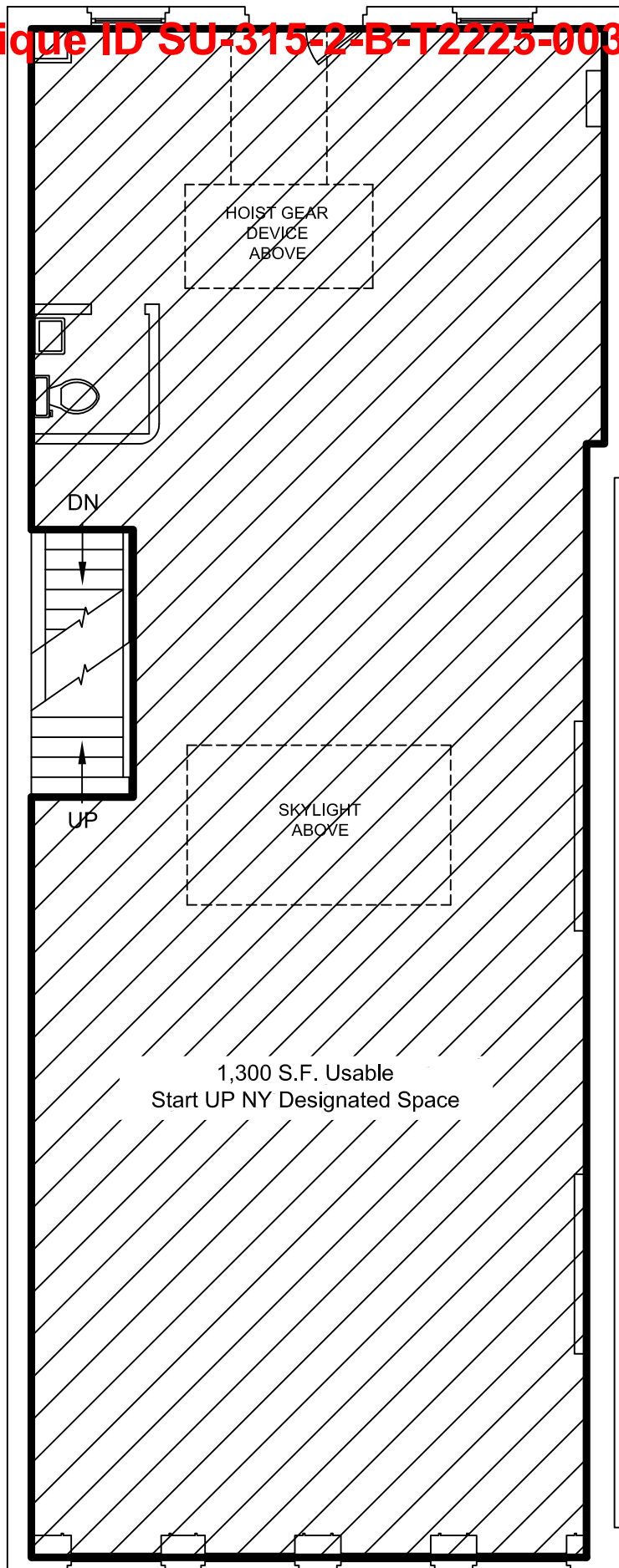

Total Square Footage 1,300

<<06/28/2016>>

226 RIVER STREET
TROY, NY
3RD FLOOR

JUDGE
Development Corp.

255 RIVER STREET
TROY, NY 12180
P. 518-274-3325
F. 518-274-4833



**Burdett Building 251 River Street
Fifth Floor, Troy, NY 12180**



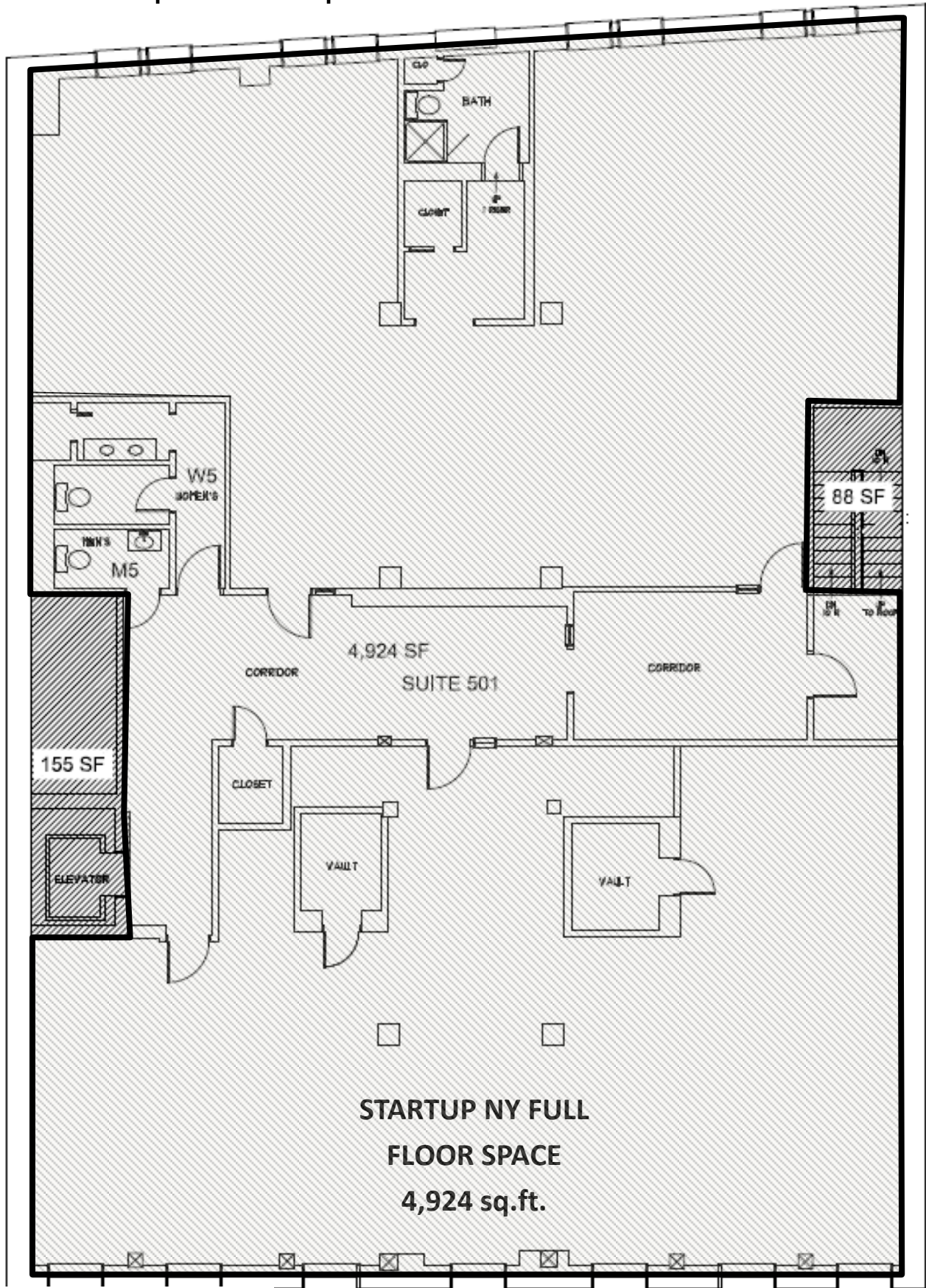

**STARTUP NY FULL
FLOOR SPACE
4,924 sq.ft.**

StartUp NY Unique ID SU-315-2-B-T2255-001-A

StartUp NY Unique ID SU-315-2-B-T2255-002-A

**HVCC
Downtown
Troy**

**McCarthy Building 255 River Street
First Floor, Mezzanine,
Second Floor
Troy, NY 12180**



Total Square Feet Building 10,888



2/24/2017



**255 RIVER STREET
TROY, NY
1ST FLOOR
4,654 sq.ft.**

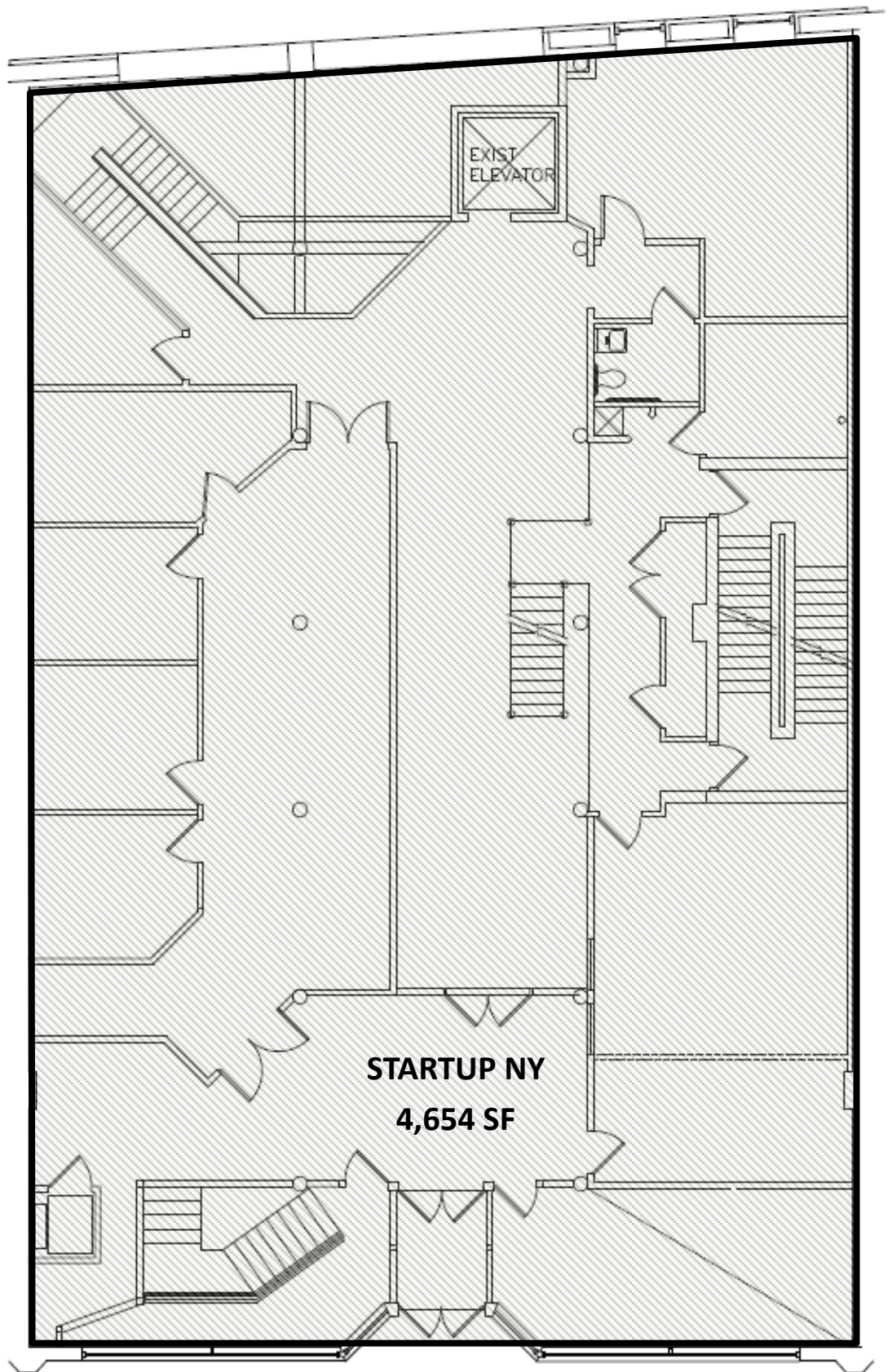

NIA Platform
14 Corporate Woods
Boulevard
Albany, New York 12211
518-465-1400 x225

Total Square Feet StartUP NY Space 5,987

2/14/2017



**255 RIVER STREET
TROY, NY 12180
1st floor
mezzanine
1,333 sq.ft.**

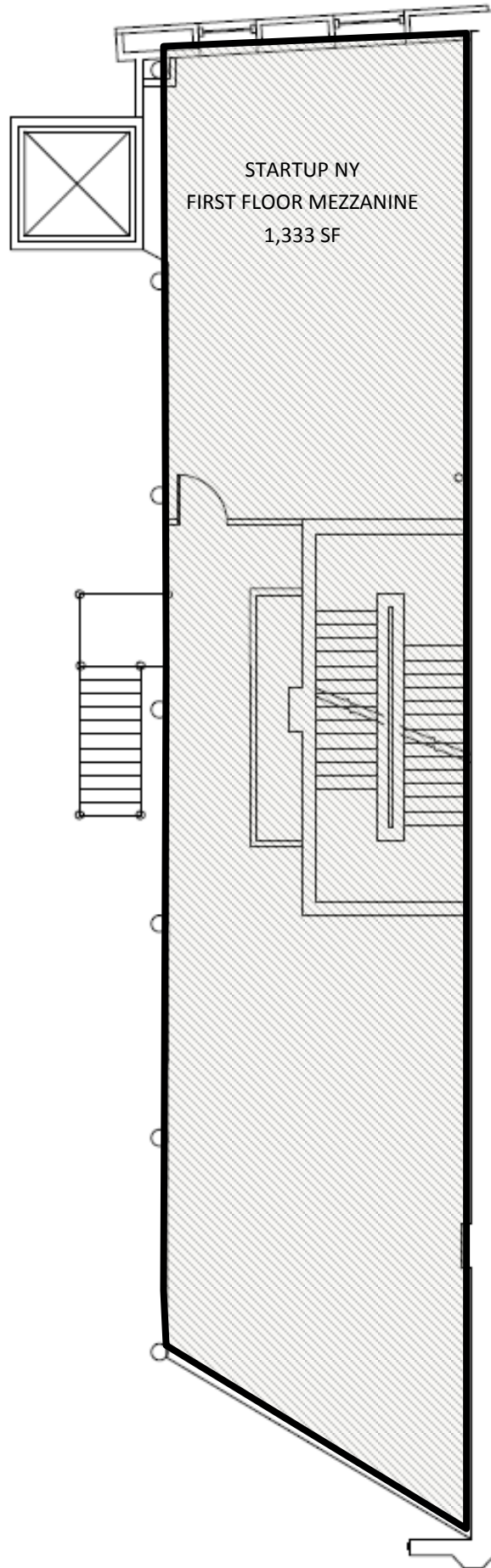

NIA Platform
14 Corporate Woods
Boulevard
Albany, New York 12211
518-465-1400 x225

2/24/2017

Total Square Feet StartUP NY Space 5,987

StartUp NY Unique ID SU-315-2-B-T2255-002-A

**255 RIVER STREET
TROY, NY
2ND FLOOR
4,901 sq.ft.**

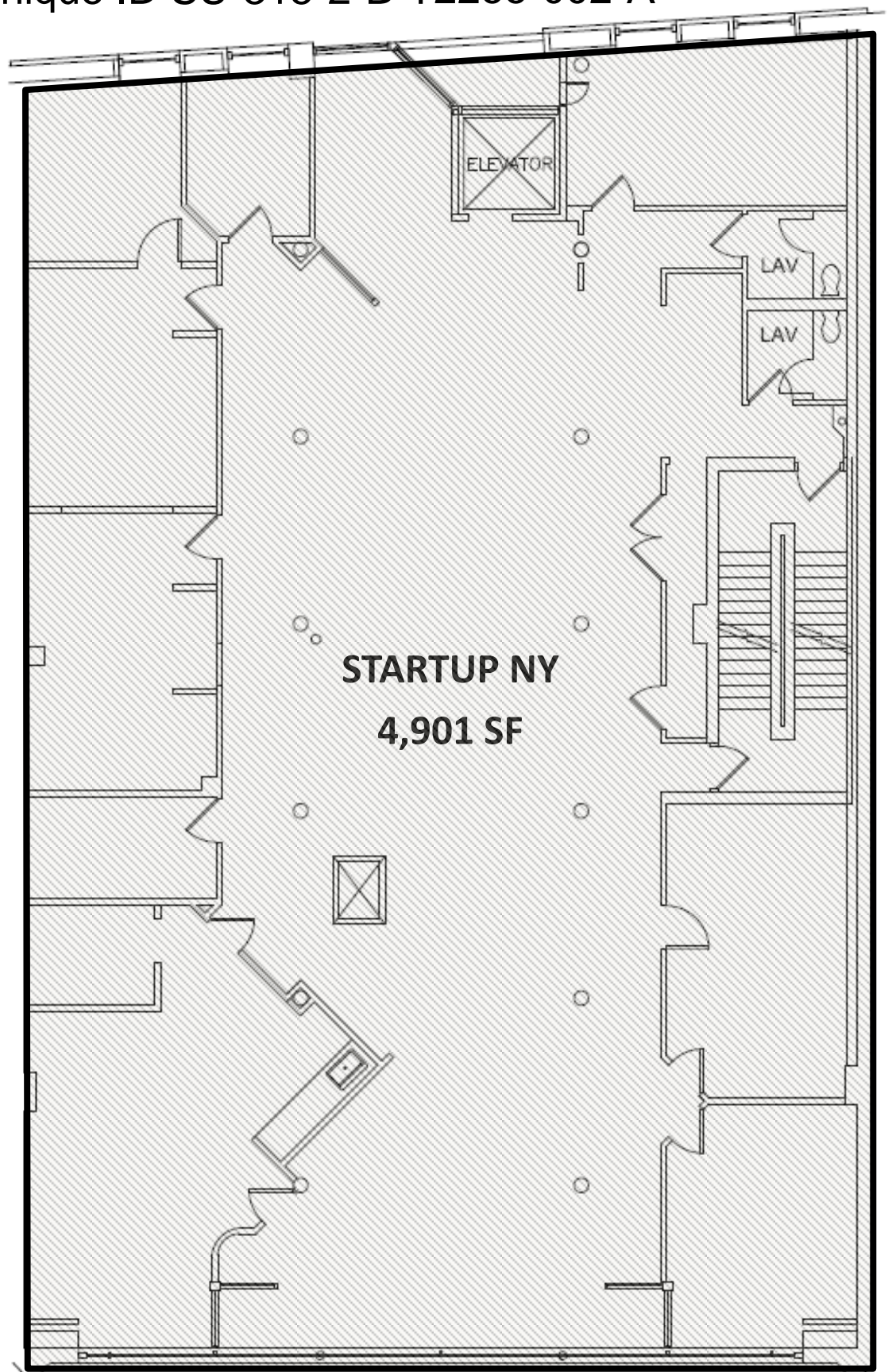

NIA Platform
14 Corporate Woods
Boulevard
Albany, New York 12211
518-465-1400 x225



2/24/2017

HVCC DOWNTOWN

StartUP NY Unique ID

SU-315-2-B-T2403-002-A

403 Fulton Street
Troy, NY 12180



SU-315-2-B-T2403-003-A



Total Tax Free Area 6,115 Building

02/24/17

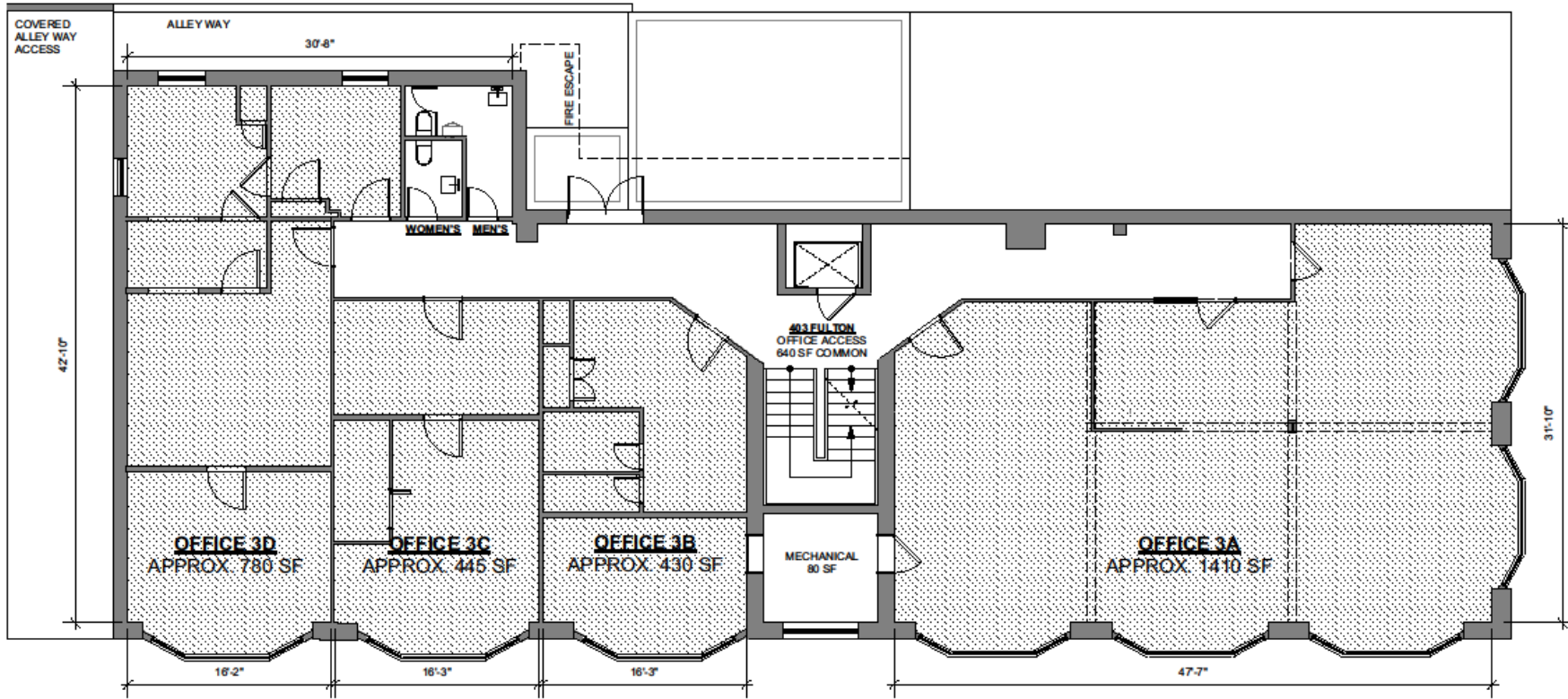

STARTUP NY
2ND FLOOR TOTAL AVAILABLE SF: 3,065

1 SECOND FLOOR
 Scale: 1/8" = 1'-0"

F U L T O N S T R E E T



Tax Free Area 3,065 2ND Floor

02/24/17

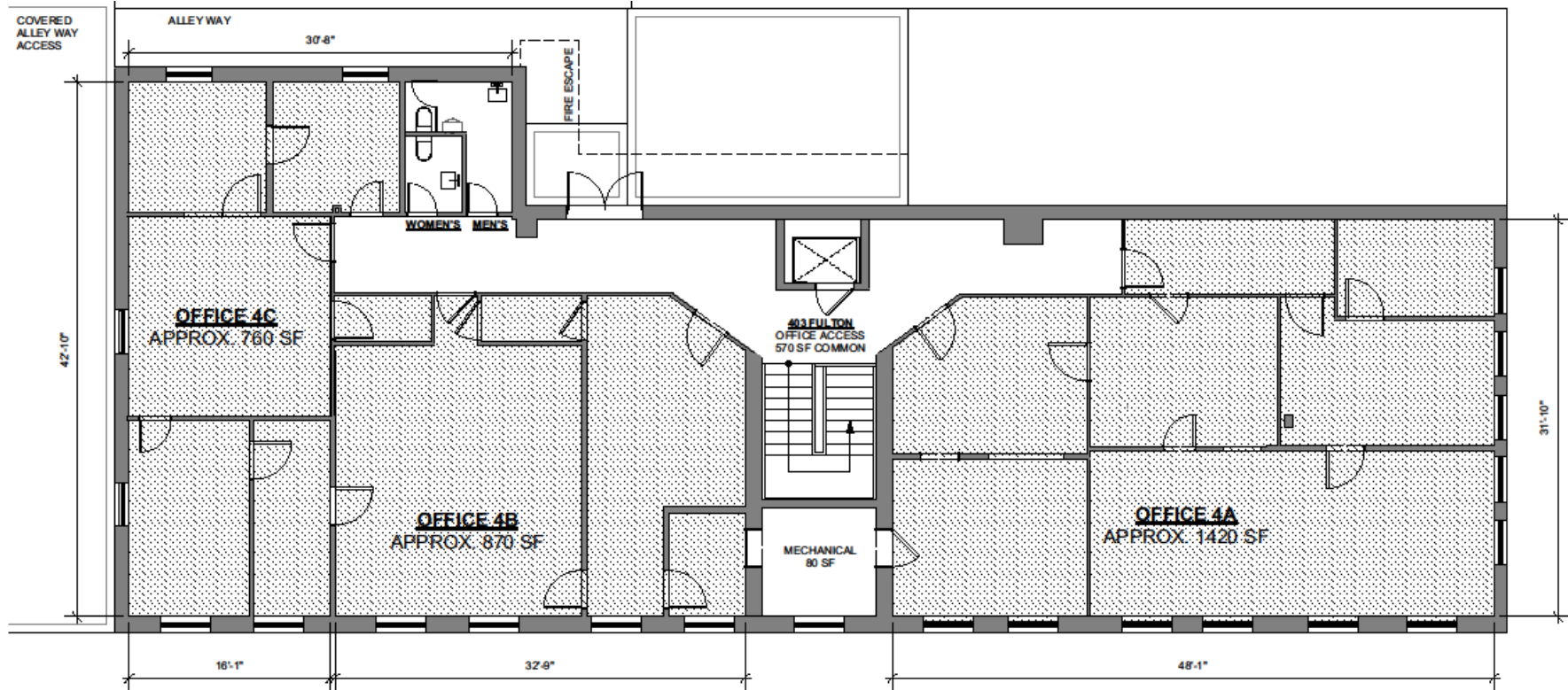

STARTUP NY
3RD FLOOR TOTAL AVAILABLE SF: 3,050

1 3RD FLOOR
 Scale: 1/8" = 1'-0"

F U L T O N S T R E E T



Tax Free Area 3,050 Third Floor

02/24/17

HVCC
DOWNTOWN TROY

StartUP NY Unique ID SU-315-2-B-T2005-001-A

StartUP NY Unique ID SU-315-2-B-T2005-002-A

StartUP NY Unique ID SU-315-2-B-T2005-003-A

StartUP NY Unique ID SU-315-2-B-T2005-004-A



5 First St., Floors 1-4 Troy, NY 12180



Total Tax Free Area 11,547

02/24/17

HVCC DOWNTOWN TROY

StartUP NY Unique ID SU-315-2-B-T2005-001-A

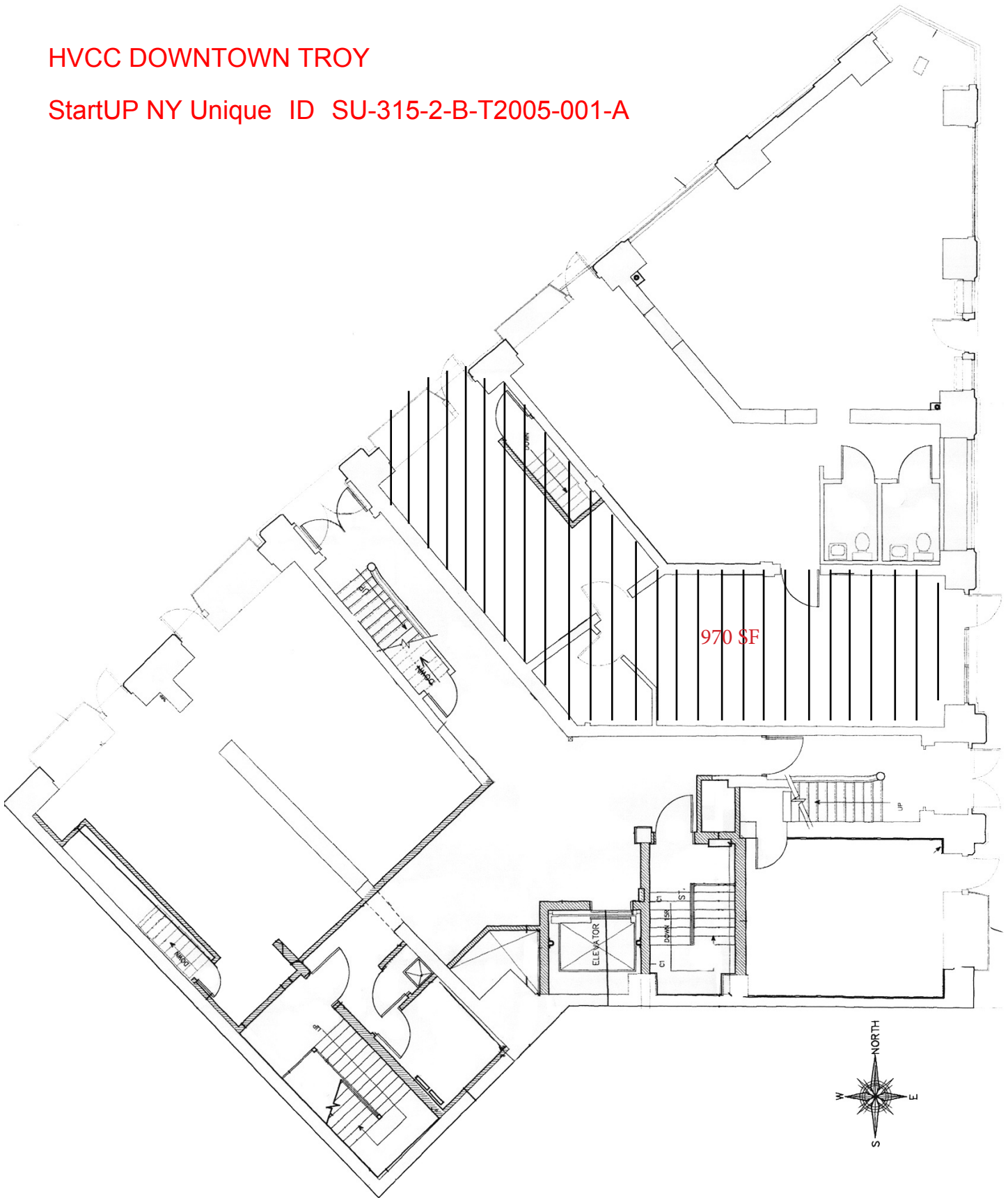

Rice Building First Floor

Total Tax Free Area 970

**Rice Building
5 First Street
Troy, NY 12180**

02/24/17

StartUP NY Unique ID SU-315-2-B-T2005-002-A

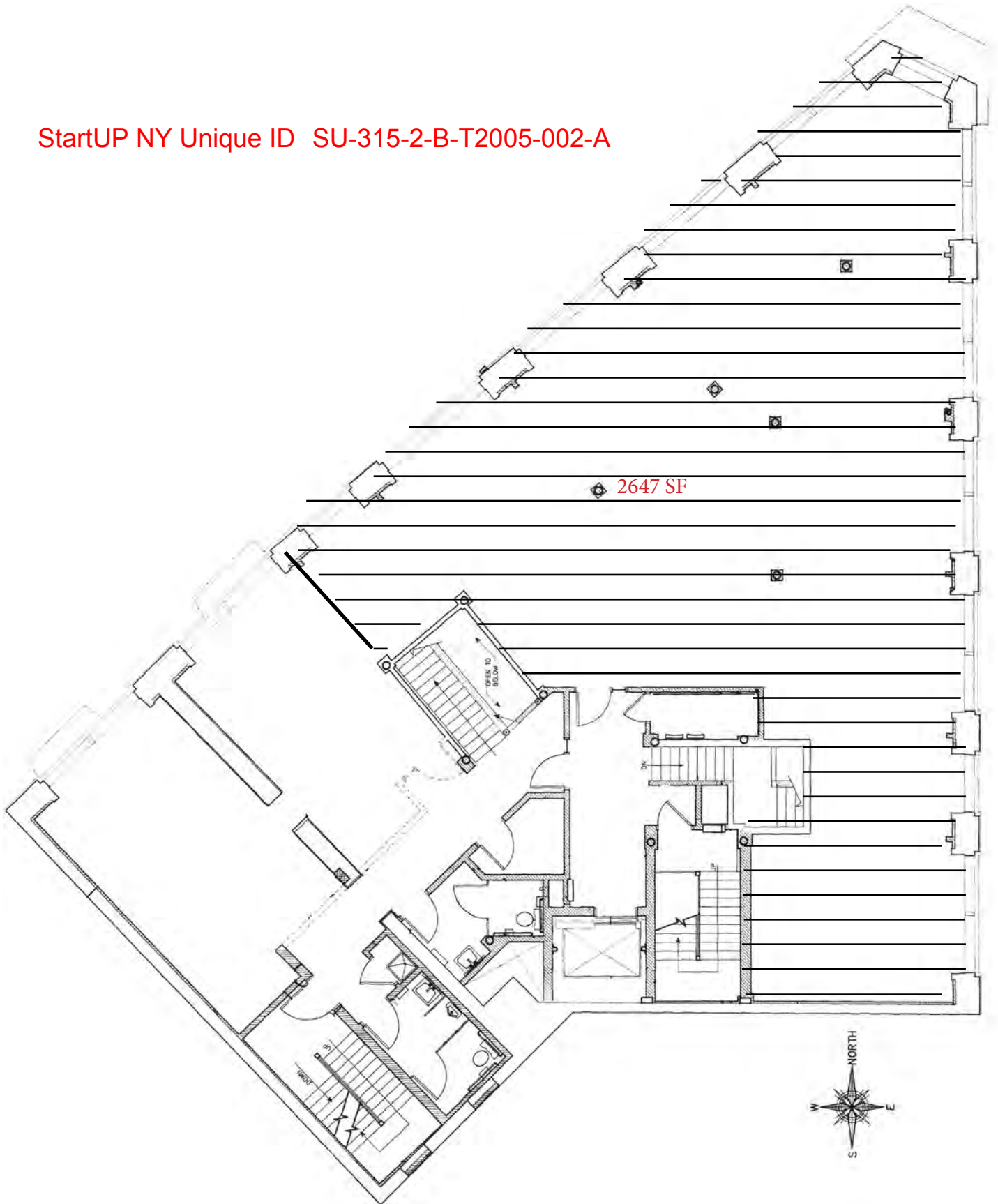

Rice Building Second Floor
Total Tax Free Area 2,647

Rice Building
5 First Street
Troy, NY 12180

02/24/17

StartUP NY Unique ID SU-315-2-B-T2005-003-A

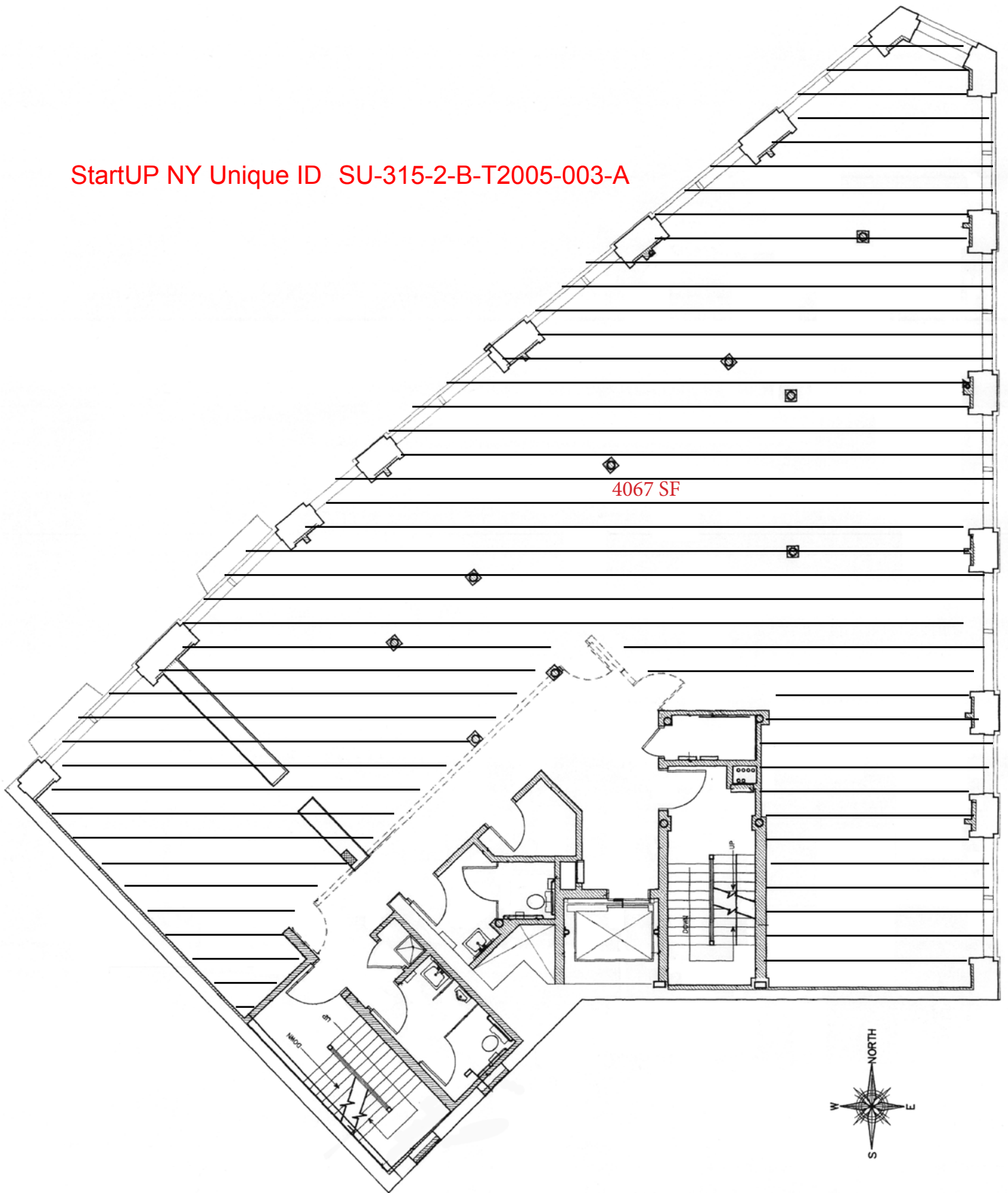

Rice Building Third Floor

Total Tax Free Area 4,067

Rice Building
5 First Street
Troy, NY 12180

02/24/17

StartUP NY Unique ID SU-315-2-B-T2005-004-A

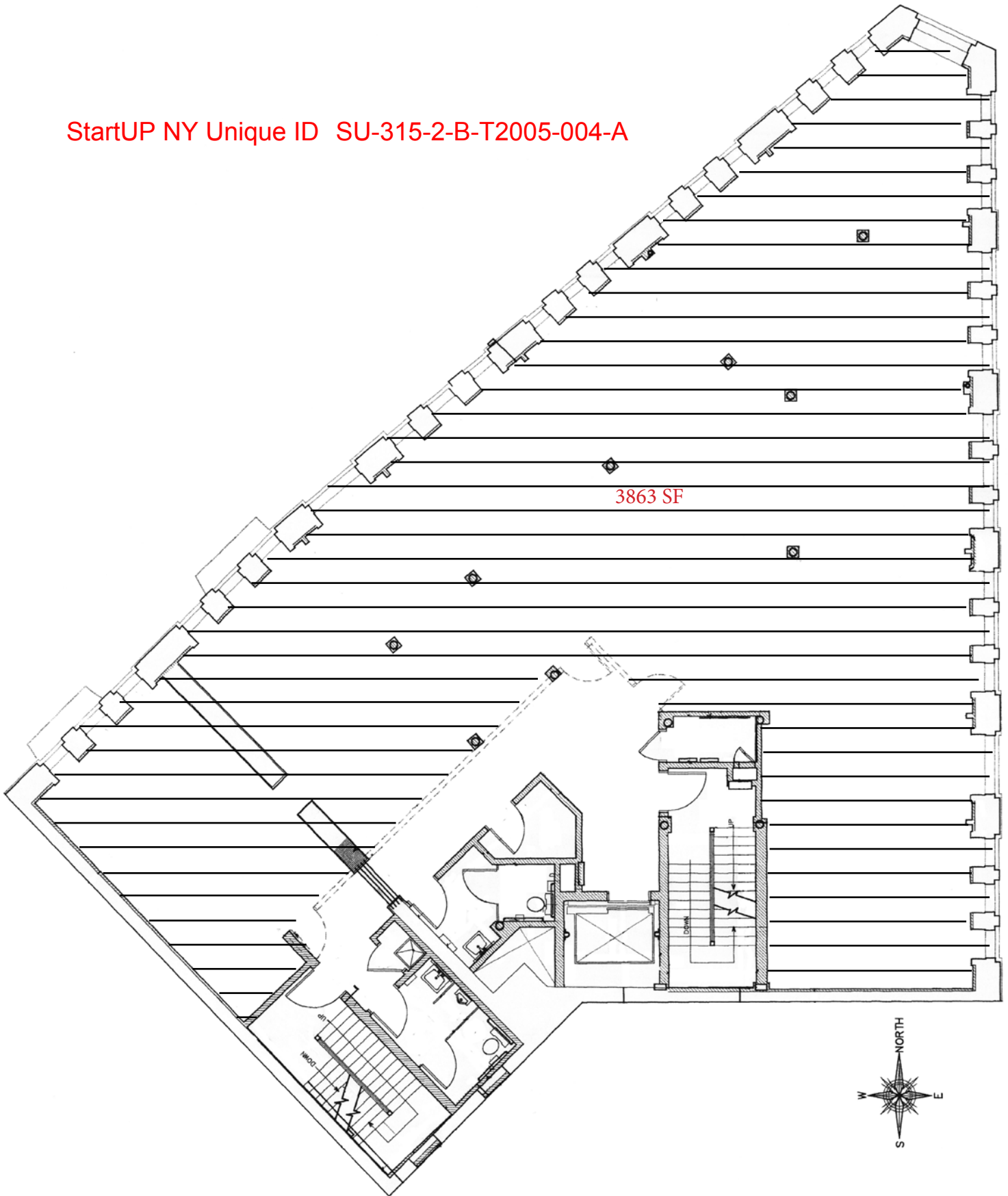

Rice Building Fourth Floor

Total Tax Free Area 3,863

Rice Building
5 First Street
Troy, NY 12180

02/24/17

HVCC DOWNTOWN

StartUP NY Unique ID SU-315-2-B-T2247-001-A

StartUP NY Unique ID SU-315-2-B-T2247-002-A



Not To Scale

Prepared by: C. Wyllie
Date: 2-13-2017

Owner:
12th Street Ventures, LLC
36 Belle Ave., Troy, NY 12180

Total Tax Free Area 5,544 Building

Designated
Space for:



Area of First Floor: 2,772 S.F.
Area of Second Floor: 2,772 S.F.
Total Area: 5,544 S.F.

Center of Purposeful Creation

(Corner of Hutton & 13th Street)

2247 13th Street
Troy, NY 12180

Tax Parcel: 101.39-1-9 (Rensselaer County)
Latitude 42°44'11" Longitude -73°40'40"

Sheet 1 of 3

02/24/17

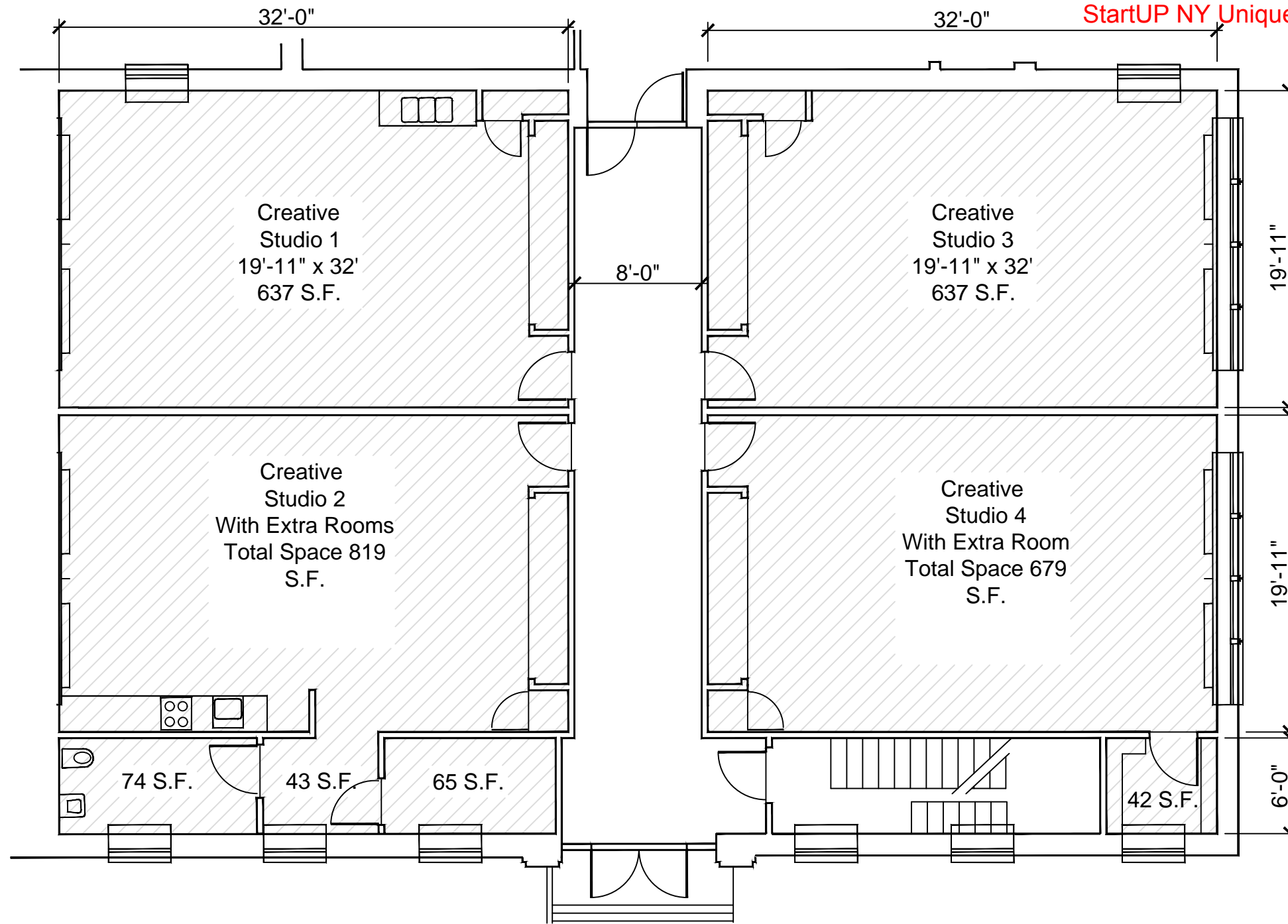

HVCC StartUp NY Unique ID _____

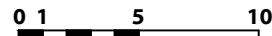

Scale: 1/8" = 1'

Prepared by: C. Wyllie
Date: 2-13-2017

02/24/17

First Floor Plan (Total designated space First Floor = 2,772 S.F.)

Owner:
 12th Street Ventures, LLC
 36 Belle Ave., Troy, NY 12180

Designated Space for: **STARTUP NY**

Area of First Floor: 2,772 S.F.
Area of Second Floor: 2,772 S.F.
Total Area: 5,544 S.F.

Center of Purposeful Creation

(Corner of Hutton & 13th Street)

2247 13th Street

Troy, NY 12180

Tax Parcel: 101.39-1-9 (Rensselaer County)

Latitude 42°44'11" Longitude -73°40'40"

A-1.1

FIRST FLOOR LAYOUT

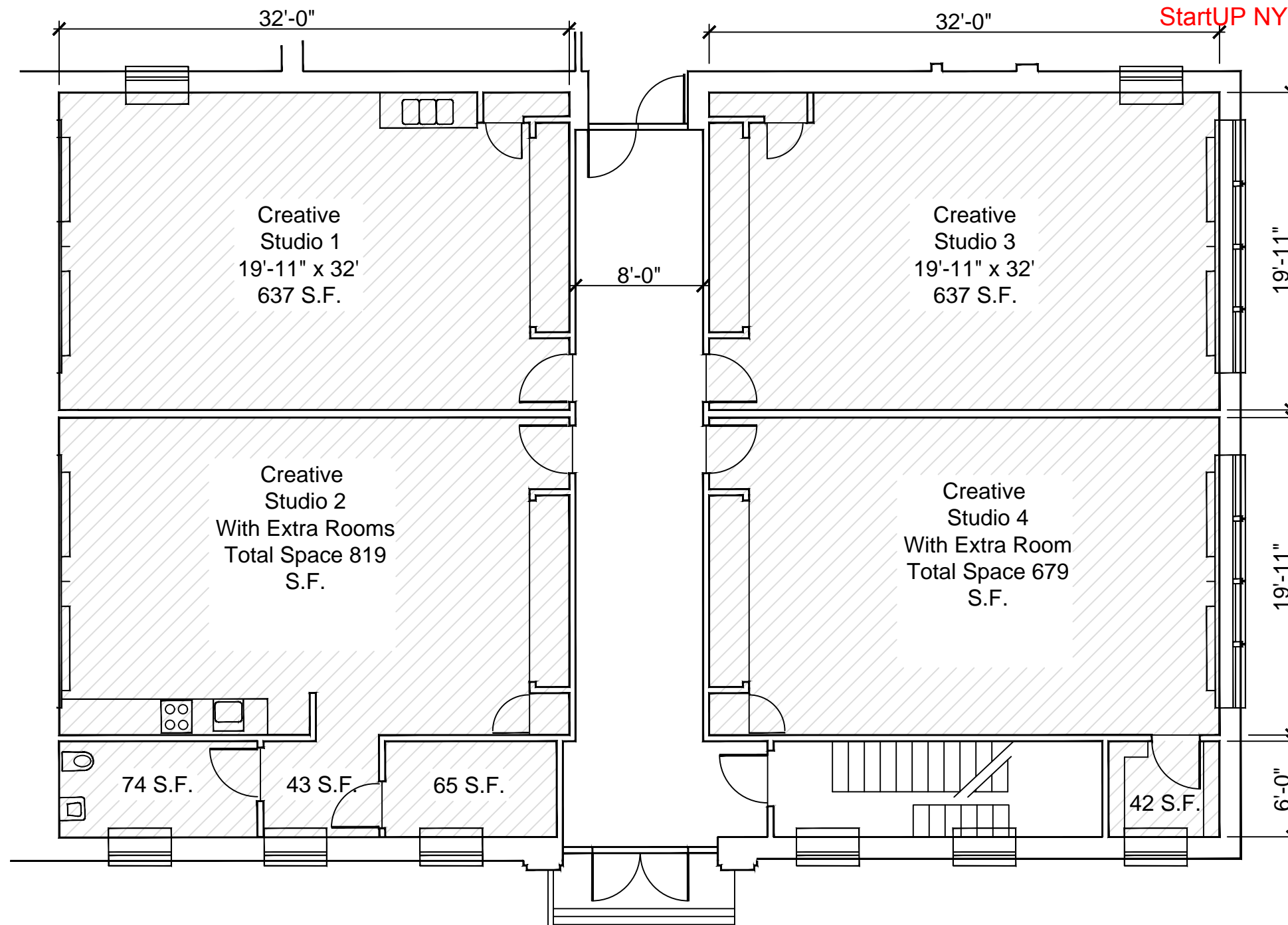

Scale: 1/8" = 1'

Prepared by: C. Wyllie
Date: 2-13-2017

Second Floor Plan (Total designated space Second Floor = 2,772 S.F.)

Sheet 3 of 3

02/24/17

Owner:
12th Street Ventures, LLC
36 Belle Ave., Troy, NY 12180

Total Tax Free Area 2,772

Designated Space for:



Area of First Floor: 2,772 S.F.
Area of Second Floor: 2,772 S.F.
Total Area: 5,544 S.F.

Center of Purposeful Creation

(Corner of Hutton & 13th Street)

2247 13th Street

Troy, NY 12180

Tax Parcel: 101.39-1-9 (Rensselaer County)

Latitude 42°44'11" Longitude -73°40'40"

A-1.2

SECOND FLOOR LAYOUT



Hamilton Building
22 Hamilton Way, Castleton-on-Hudson, NY 12033



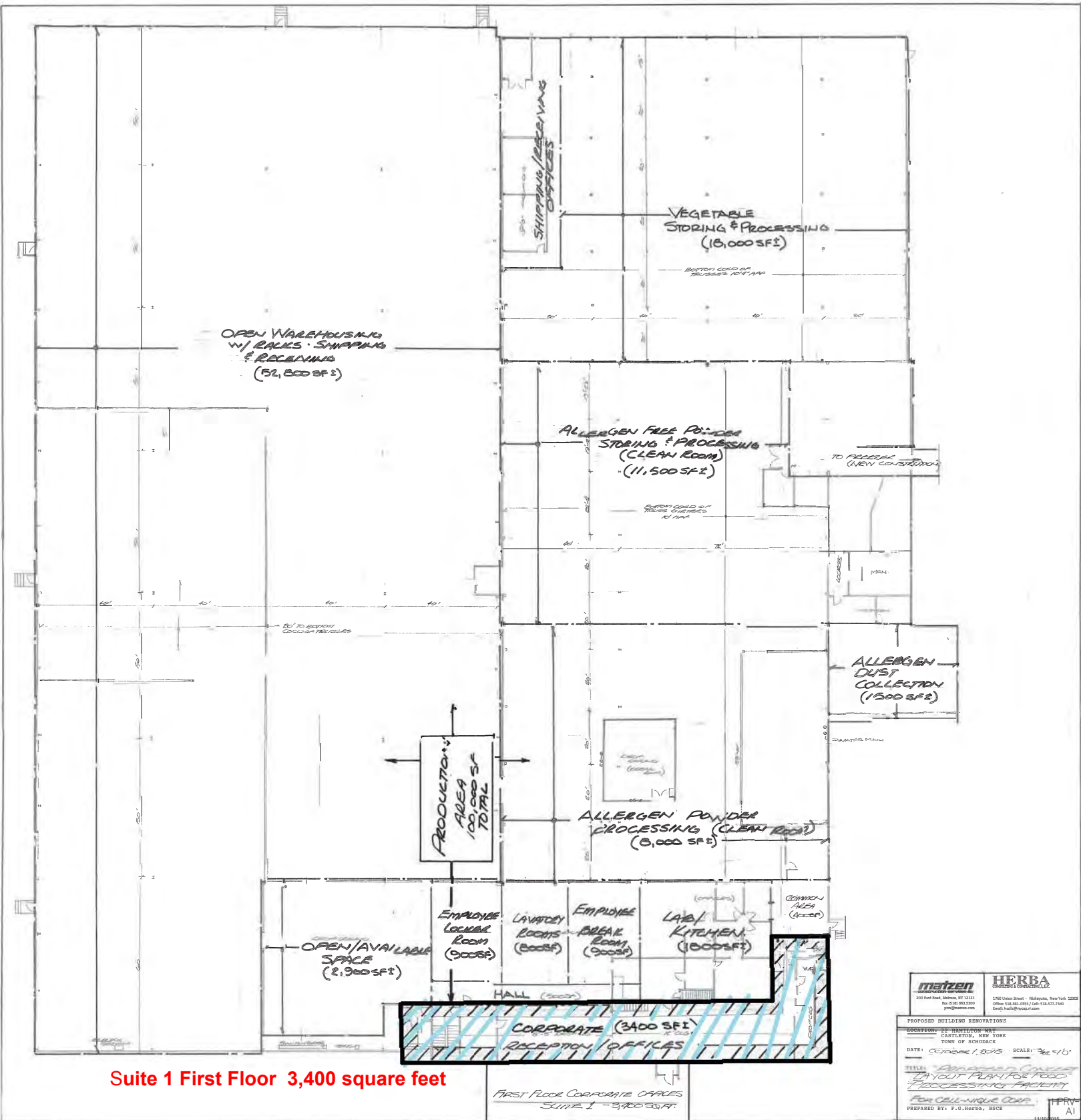

Suite 1 First Floor 3,400 square feet

metzen
ARCHITECTURE & INTERIORS, LLC
200 Ford Road, Melville, NY 11761
Tel: 516.433.2200
metzen.com

HERBA
CONSTRUCTION, LLC
1700 Union Street - Millington, New York 12542
Office: 518.945.0200 | Fax: 518.477.9744
herba@herba-ny.com

PROPOSED BUILDING RENOVATIONS
LOCATION: 25 HAMILTON WAY
CASTLETON, NEW YORK
TOWN OF SCHOENACK

DATE: October 1, 2015 - SCALE: 3/8" = 1'-0"

TITLE: Proposed General LAYOUT PLAN FOR FOOD PROCESSING FACILITY

FOR CELL-SCALE CORP.

PREPARED BY: F.G. Herba, RCE

HPV
AI

matzen
 construction services llc.
 200 Ford Road, Mahwah, NJ 12121
 Fax: (978) 663-3300
 pm@matzen.com

HERBA
 CONSULTING & CONTRACTING, LLC
 1790 Union Street - Hightstown, New Jersey 08520
 Office: 609-381-0331 / Cell: 609-381-7730
 Email: herba@mystartny.com

PROPOSED BUILDING RENOVATIONS

LOCATION: 22 HAMILTON WAY
CASTLETON, NEW YORK
TOWN OF SCHOENACK

DATE: OCTOBER 1, 2015 SCALE: 3/8"=1'-0"

TITLE: SECOND FLOOR OFFICE
AREA - EXISTING
FOR CELL-NYUKE CORP.

PREPARED BY: F.G. Herba, BSCE

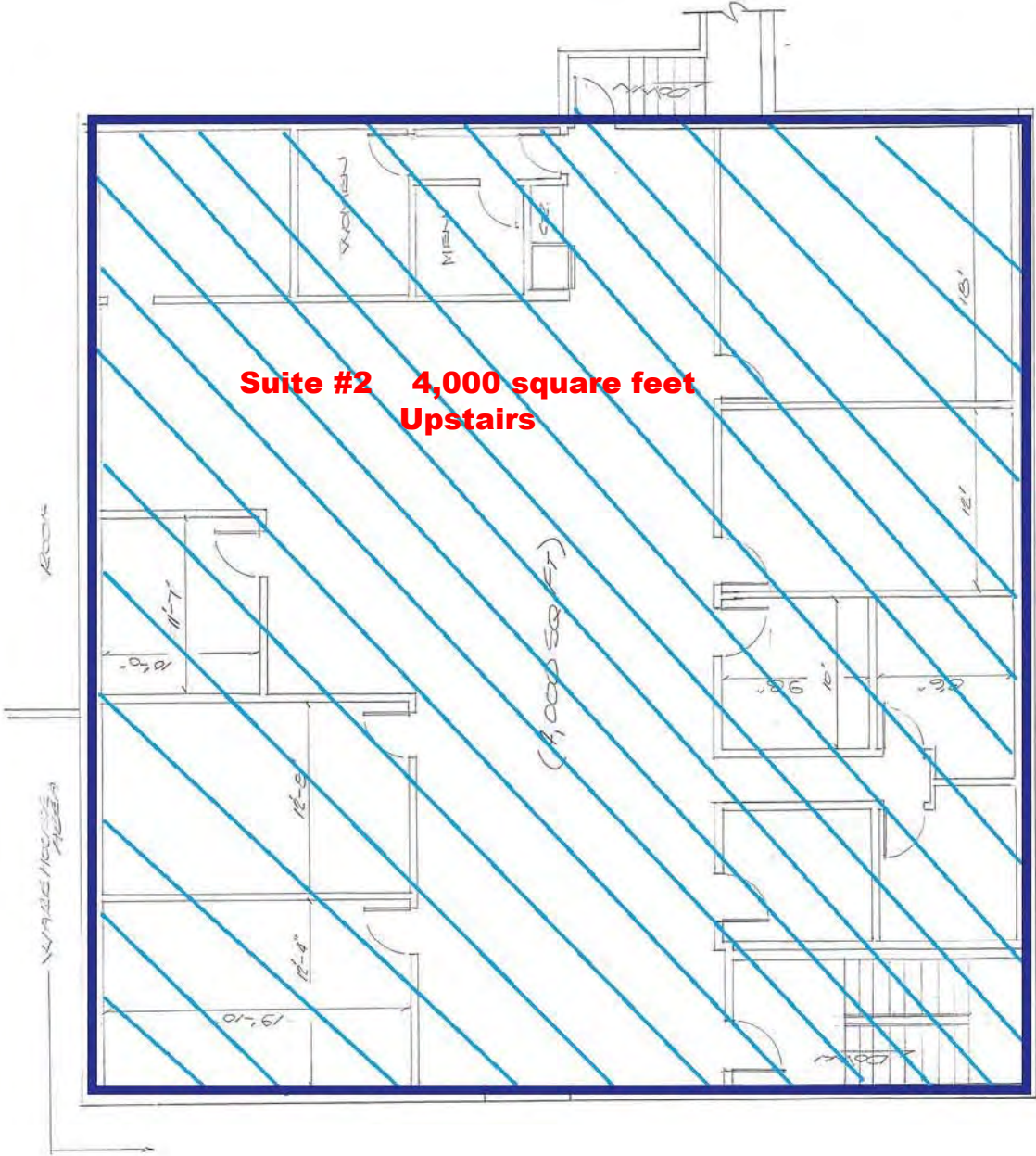

**Suite #2 4,000 square feet
Upstairs**

FLOOR PLAN 3/8"=1'-0"
(SUITE 2)



HVCC Malta

StartUP NY Unique ID SU-315-2-M107-001-A

StartUP NY Unique ID SU-315-2-M107-002-A

107 Hermes Road
Malta, NY 12020

Total Tax Free Area 31,304 Square Feet

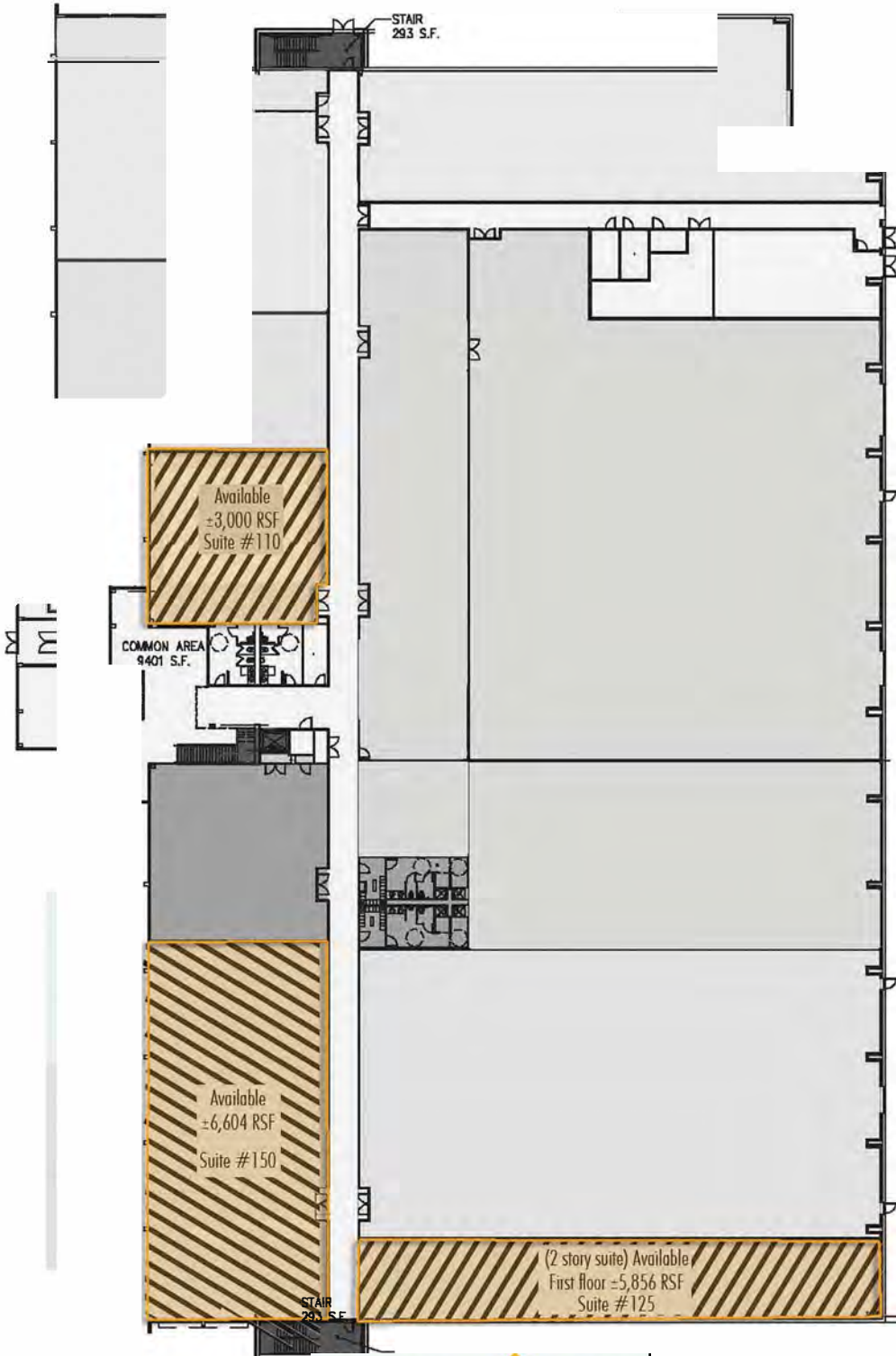

107 Hermes Road
Malta, NY 12020



Tax Free Area 20,110 sq. ft.

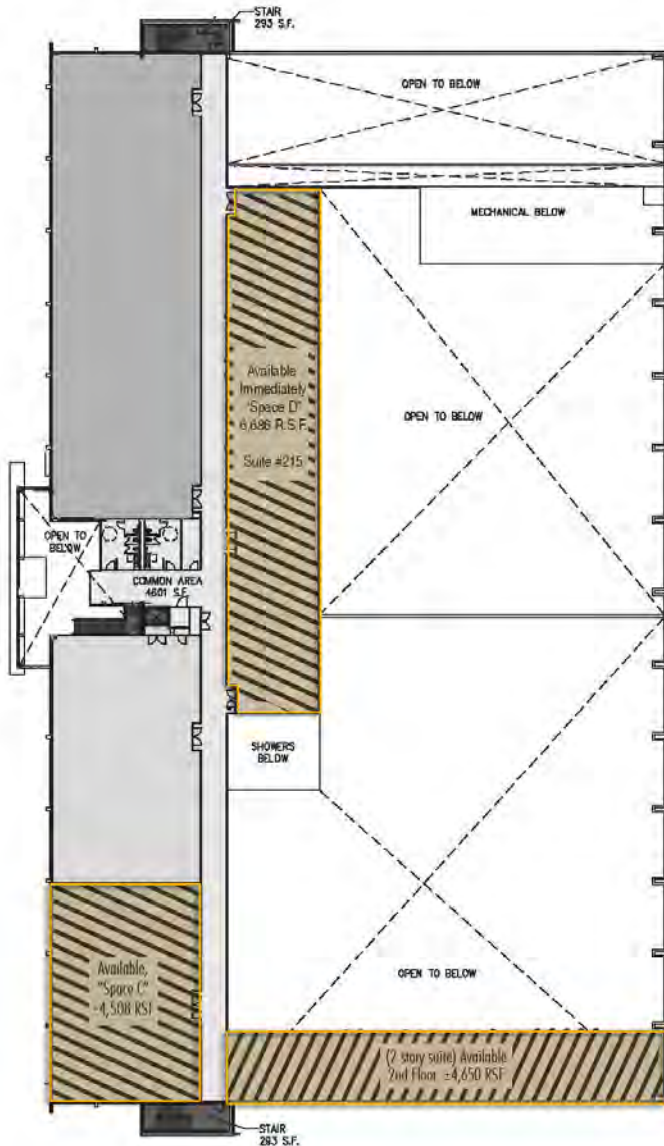

107 Hermes Road
Malta, NY 12020



Tax Free Area 11,194 sq. ft.



StartUP NY Unique ID SU-315-1-B-T2019-002-A



Total Tax Free Area 7,057 Square Feet

ON-CAMPUS SPACE -MOU Rensselaer County IDA

19 Third Street
Troy, NY 12180

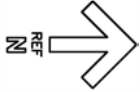

1/16" = 1'-0"
TOTAL SQUARE FEET: 7,057

SECOND FLOOR PLAN

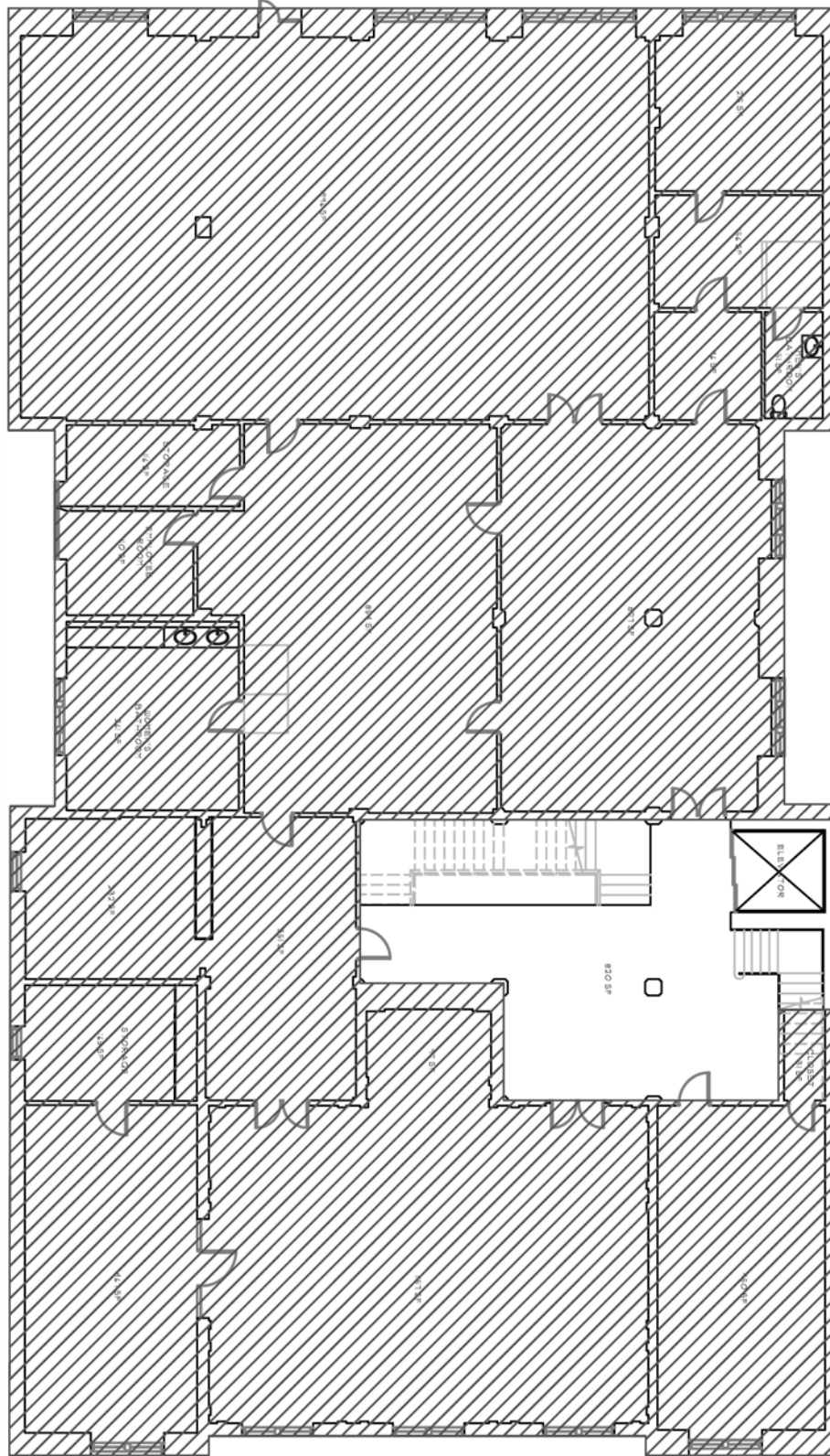

Total Tax Free Area 7,057 Square Feet

ON-CAMPUS SPACE MOU Rensselaer County IDA

JOB: 183001

SHDG

TAP, INC.
210 RIVER ST.
TROY, NY 12180
(518) 274-3050



DATE: 07/02/18
DRAWN BY:
REVISIONS:

PROJECT: EXISTING CONDITIONS
19 THIRD ST
TROY, NY 12180
CLIENT: MASONIC HALL

TITLE:
SECOND FLOOR
PLAN

HVCC

StartUp NY Unique ID SU-315-1-B-T2005-00A-A

StartUp NY Unique ID SU-315-1-B-T2005-00B-A



**5 East Industrial Parkway,
Plot A and Plot B
Troy, NY 12180**



Total ON-CAMPUS Land 11.25 Acres

HVCC

Unique ID SU-315-1-L-T2005-00A-A

Unique ID SU-315-1-L-T2005-00B-A

111.35-1-1./1

111.44-1-30

SU-315-1-L-T2005-00A-A

PLOT A 4.30 acres

111.43-1-1
(4.30Ac)

5 East Industrial Parkway

City of Troy

11.25 Ac

111.51-1-1

111.59-2-2

111.44-1-30.2

1ST-STREET-ALY

EAST-INDUSTRIAL-PKWAY

1ST-ST

PLOT B 6.95 acres

SU-315-1-L-T2005-00B-A

TYLER-ST

111.51-1-4

111.51-1-3

11152 -6 1



Total ON-CAMPUS Acreage 11.25

<<06/28/2016>>



Maple Hill Middle School Basement
1477 South Schodack Road
Castleton, NY 12033



Total Sq. Ft. 6,500
ON-CAMPUS SPACE

StartUp NY Unique ID SU-315-1-B-T11477-000-A

HVCC

6,500 sq. ft.
ON-CAMPUS
StartUP NY
space

Unique
A1000 Assessment Floor Plan

Hatched area is 6,500 sq. ft. of available space.
1477 South Schodack Rd., Castleton, New York 12033

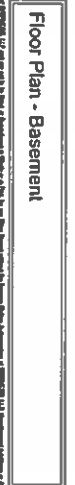
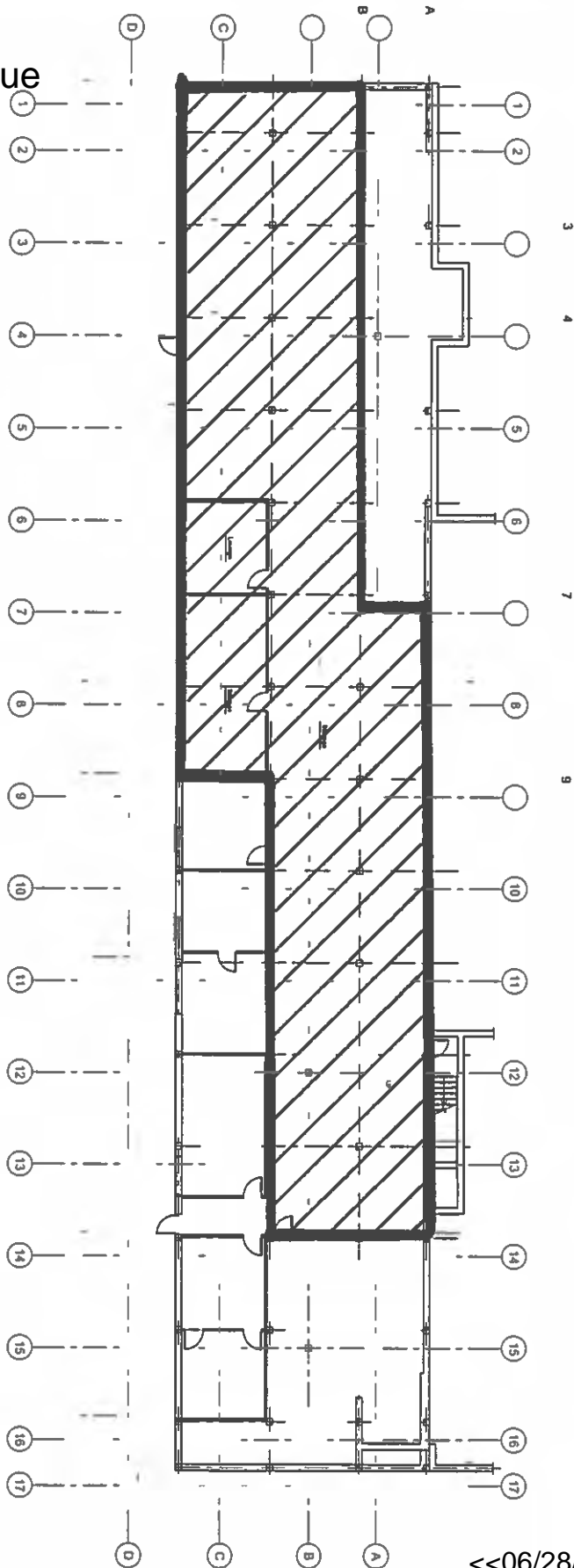

Total Square Footage 6,500

<<06/28/2016>>